



MagnumStone
RETAINING WALLS
www.magnumstone.com | 1 (800) 939-9193

MAGNUMSTONE GRAVITY EXTENDER WALL CHARTS

SHEET CONTENT

300

1102-MS-GVT

SHEET REFERENCE

GENERAL NOTES:

These drawings are intended solely to act as an aid when designing a wall. This drawing should not be used for final design or construction. Each site-specific wall should be certified and signed by a registered geotechnical engineer in the State or Province that it is being built. The accuracy and use of the details in this document are the sole responsibility of the user.

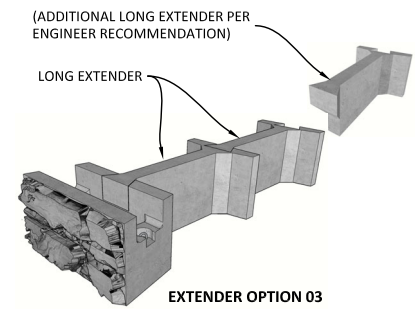
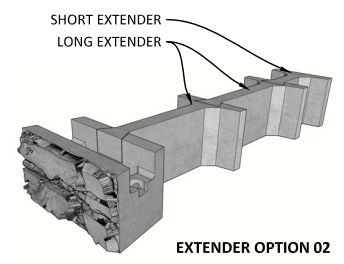
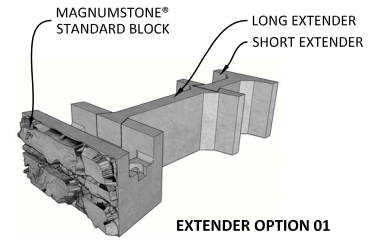
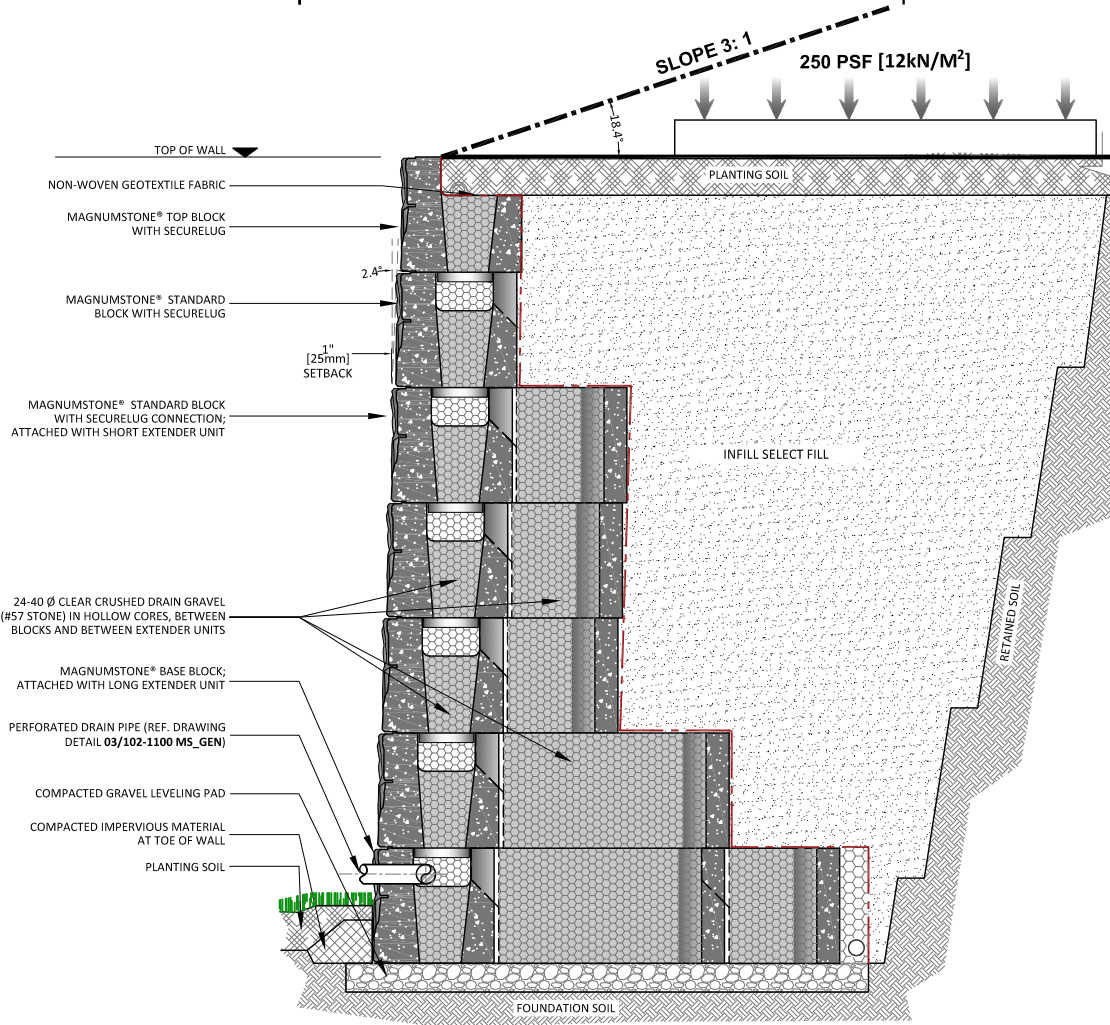

GRAVITY WALL TYPICAL CROSS SECTION

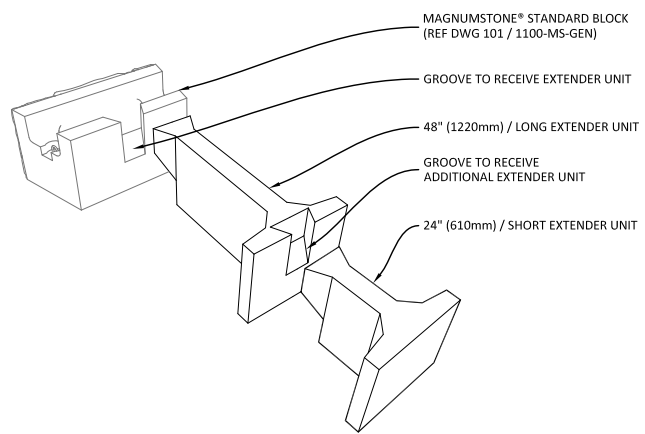

EXTENDER UNIT CONFIGURATION

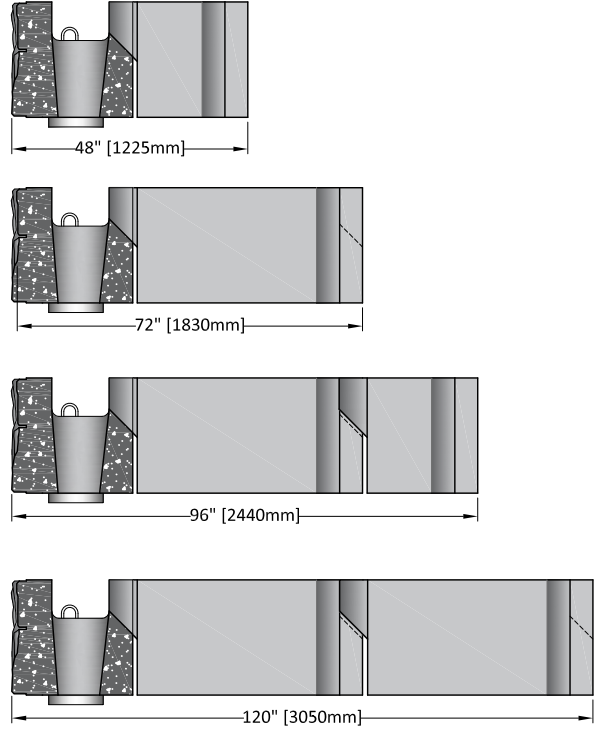

ISOMETRIC VIEW - REAR

- GENERAL NOTE:**
- FOLLOW PROPER INSTALLATION GUIDELINE AS PER THE MAGNUMSTONE® INSTALLATION MANUAL.
 - ENSURE LOCAL CODES AND GUIDELINES ARE ALWAYS BEING FOLLOWED
 - EXTENDER UNITS ARE CHAINED TOGETHER IN 2' [610mm] INCREMENTS.
 - THE NUMBER OF EXTENDERS MAY BE DETERMINED BY THE ENGINEER ON RECORD



MagnumStone
RETAINING WALLS

www.magnumstone.com | 1 (800) 939-9193

MAGNUMSTONE GRAVITY EXTENDER WALL CHARTS SELECT FILL WITH 28° RETAINED SOIL | NO LOAD

SHEET CONTENT

301

1102-MS-GVT

SHEET REFERENCE

GENERAL NOTES:

These drawings are intended solely to act as an aid when designing a wall. This drawing should not be used for final design or construction.

Each site-specific wall should be certified and signed by a registered geotechnical engineer in the State or Province that it is being built. The accuracy and use of the details in this document are the sole responsibility of the user.

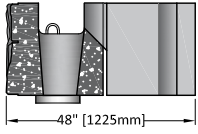

48" [1225mm]

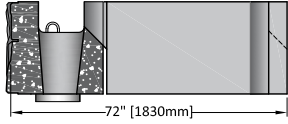

72" [1830mm]

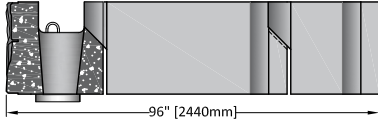

96" [2440mm]

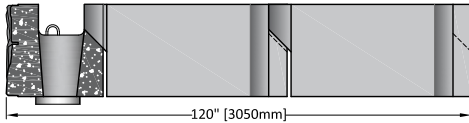

120" [3050mm]

DESCRIPTION

SLOPE ANGLE	0°
LIVE LOAD	0 PSF
RETAINED SOIL	28°
FOUNDATION	28°
INFILL SELECT FILL	34°
LEVELING PAD	CRUSHED GRAVEL

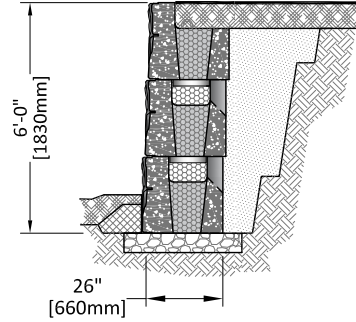

6'-0"
[1830mm]

26"
[660mm]

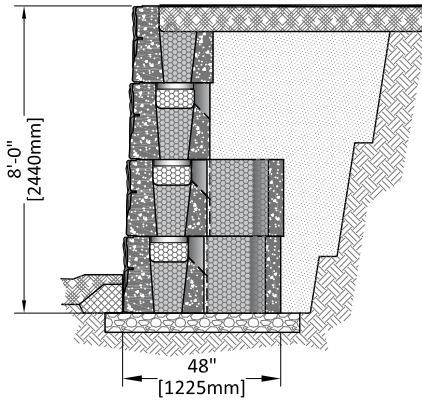

8'-0"
[2440mm]

48"
[1225mm]

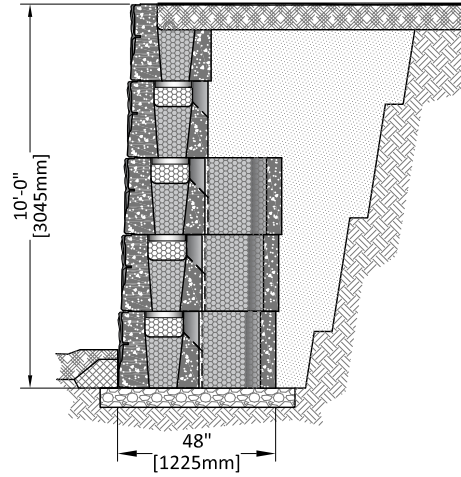

10'-0"
[3045mm]

48"
[1225mm]

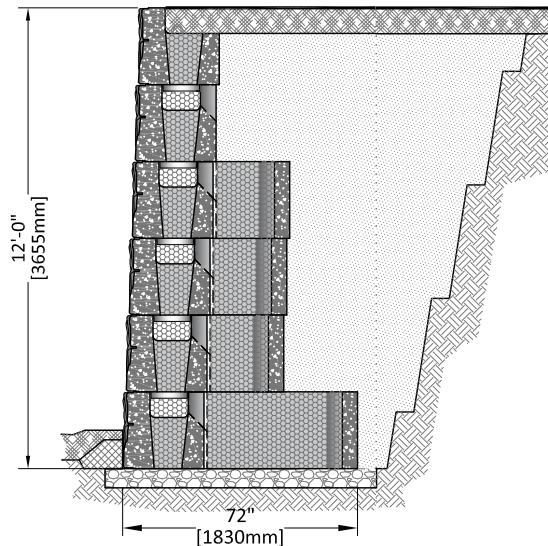

12'-0"
[3655mm]

72"
[1830mm]

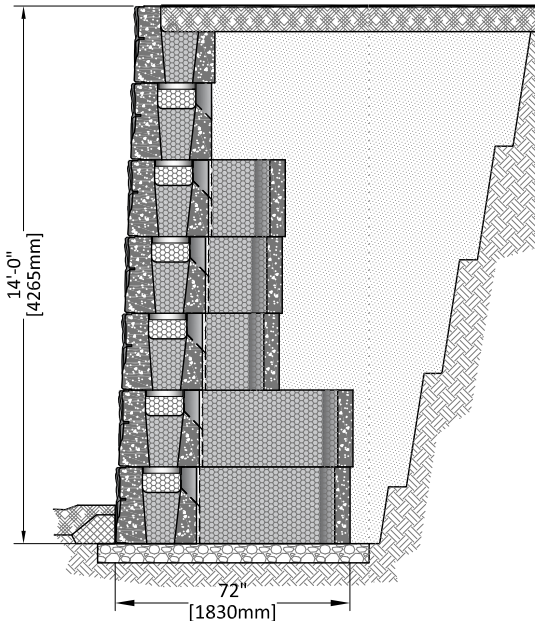

14'-0"
[4265mm]

72"
[1830mm]



MagnumStone
RETAINING WALLS

www.magnumstone.com | 1 (800) 939-9193

MAGNUMSTONE GRAVITY EXTENDER WALL CHARTS RETAINING SOIL 30° | NO LOAD

SHEET CONTENT

302

1102-MS-GVT

SHEET REFERENCE

GENERAL NOTES:

These drawings are intended solely to act as an aid when designing a wall. This drawing should not be used for final design or construction.

Each site-specific wall should be certified and signed by a registered geotechnical engineer in the State or Province that it is being built. The accuracy and use of the details in this document are the sole responsibility of the user.

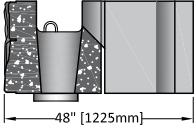

48" [1225mm]

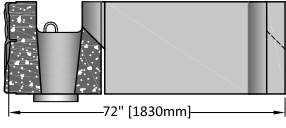

72" [1830mm]

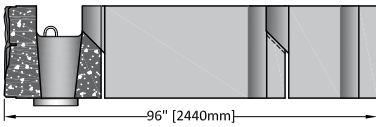

96" [2440mm]

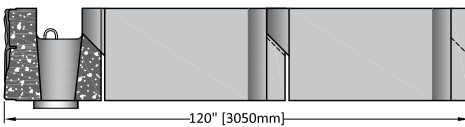

120" [3050mm]

DESCRIPTION

SLOPE ANGLE	0°
LIVE LOAD	0 PSF
RETAINED SOIL	30°
FOUNDATION	30°
INFILL SELECT FILL	30°
LEVELING PAD	CRUSHED GRAVEL

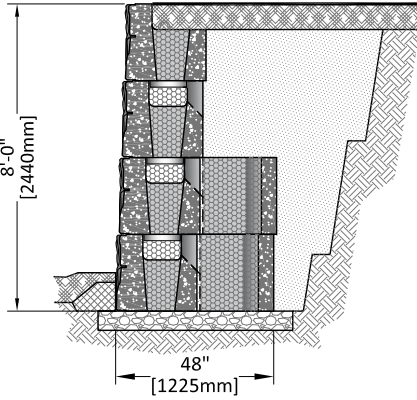

8'-0"
[2440mm]

48"
[1225mm]

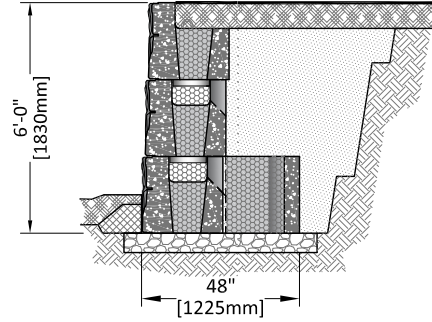

6'-0"
[1830mm]

48"
[1225mm]

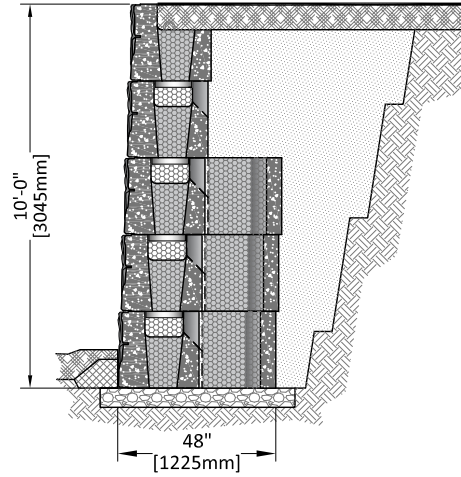

10'-0"
[3045mm]

48"
[1225mm]



12'-0"
[3655mm]

72"
[1830mm]

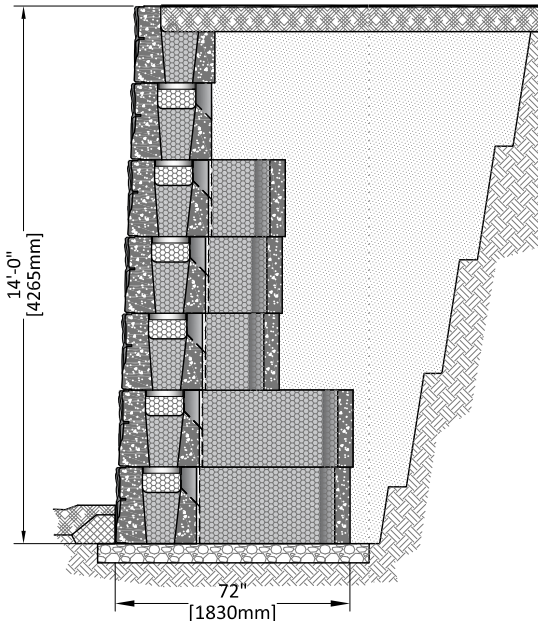

14'-0"
[4265mm]

72"
[1830mm]



MagnumStone
RETAINING WALLS

www.magnumstone.com | 1 (800) 939-9193

MAGNUMSTONE GRAVITY EXTENDER WALL CHARTS

RETAINING SOIL 28° | NO LOAD

SHEET CONTENT

303

1102-MS-GVT

SHEET REFERENCE

GENERAL NOTES:

These drawings are intended solely to act as an aid when designing a wall. This drawing should not be used for final design or construction.

Each site-specific wall should be certified and signed by a registered geotechnical engineer in the State or Province that it is being built. The accuracy and use of the details in this document are the sole responsibility of the user.

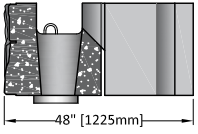

48" [1225mm]

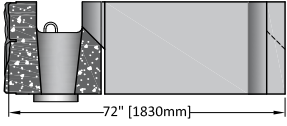

72" [1830mm]

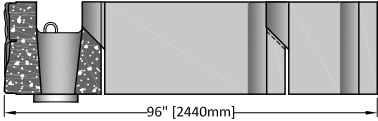

96" [2440mm]

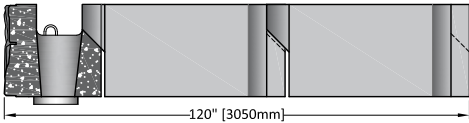

120" [3050mm]

DESCRIPTION

SLOPE ANGLE	0°
LIVE LOAD	0 PSF
RETAINED SOIL	28°
FOUNDATION	28°
INFILL SELECT FILL	28°
LEVELING PAD	CRUSHED GRAVEL

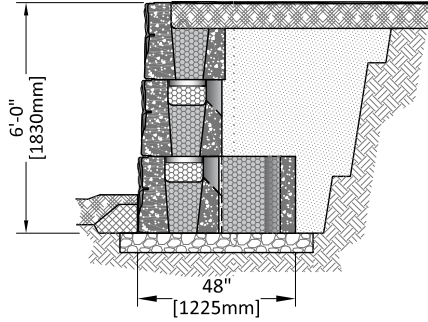

6'-0" [1830mm]

48" [1225mm]



10'-0" [3045mm]

48" [1225mm]

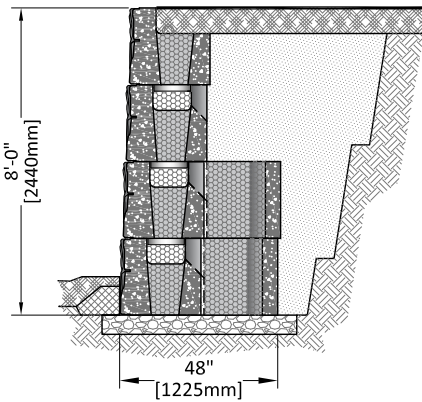

8'-0" [2440mm]

48" [1225mm]

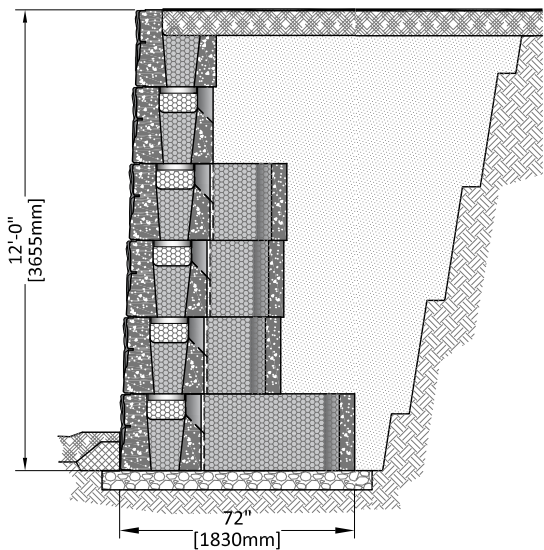

12'-0" [3655mm]

72" [1830mm]

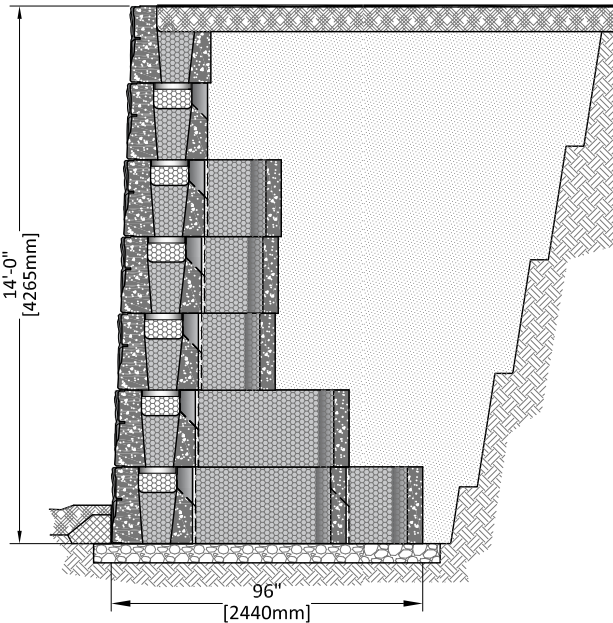

14'-0" [4265mm]

96" [2440mm]



MagnumStone
RETAINING WALLS

www.magnumstone.com | 1 (800) 939-9193

MAGNUMSTONE GRAVITY EXTENDER WALL CHARTS SELECT FILL WITH 28° RETAINED SOIL | 250 PSF [12kN/M²]

SHEET CONTENT

304

1102-MS-GVT

SHEET REFERENCE

GENERAL NOTES:

These drawings are intended solely to act as an aid when designing a wall. This drawing should not be used for final design or construction. Each site-specific wall should be certified and signed by a registered geotechnical engineer in the State or Province that it is being built. The accuracy and use of the details in this document are the sole responsibility of the user.

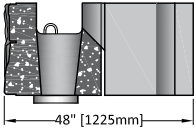

DESCRIPTION

SLOPE ANGLE	0°
LIVE LOAD	250 PSF
RETAINED SOIL	28°
FOUNDATION	28°
INFILL SELECT FILL	34°
LEVELING PAD	CRUSHED GRAVEL

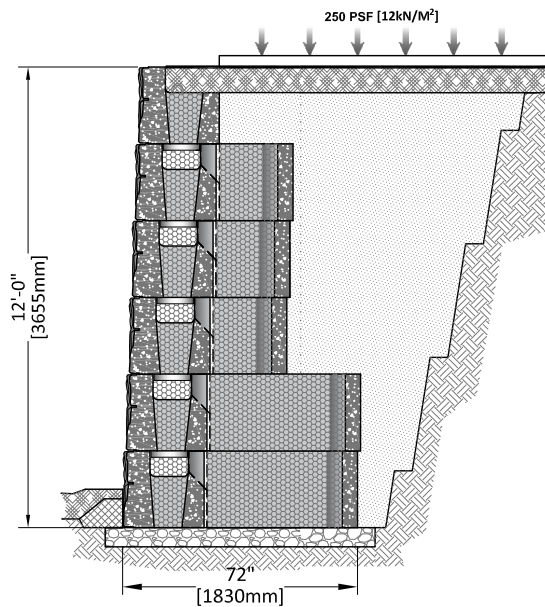
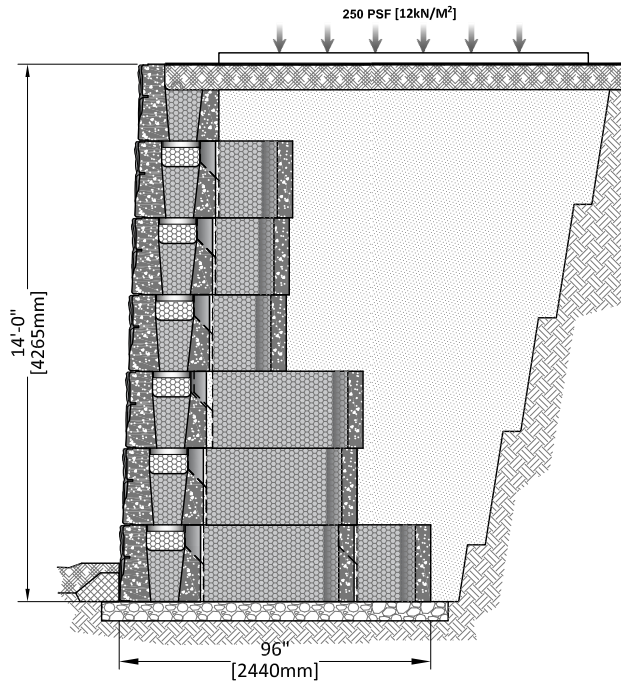
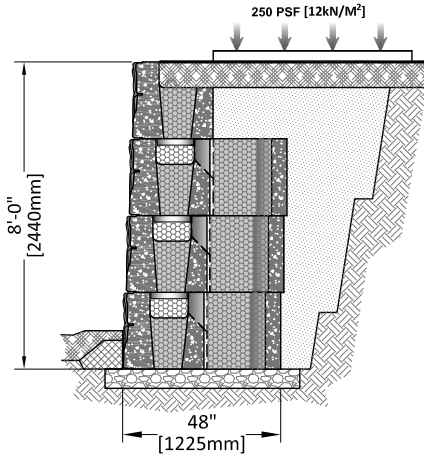
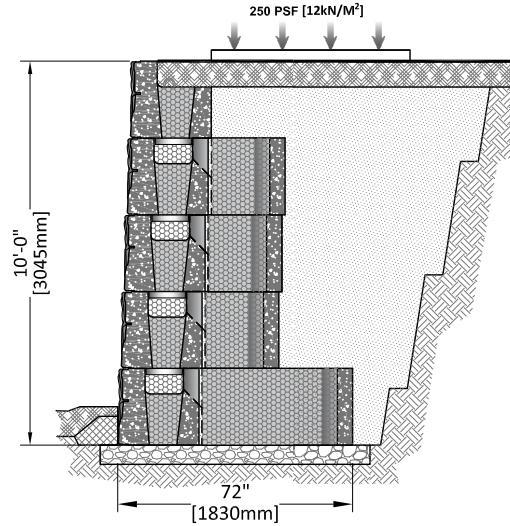
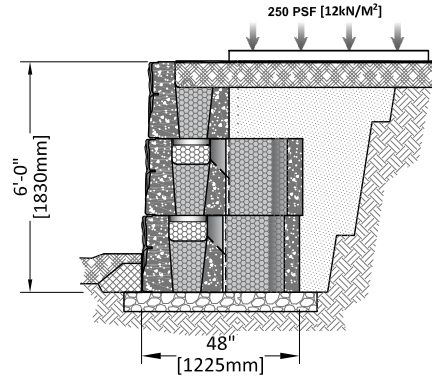
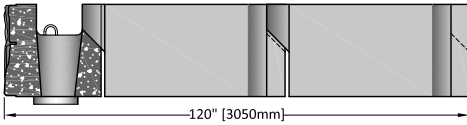
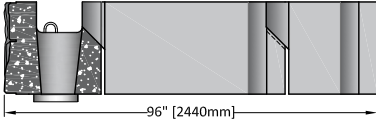
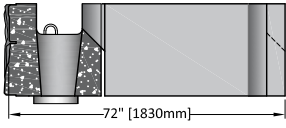



MagnumStone
RETAINING WALLS

www.magnumstone.com | 1 (800) 939-9193

MAGNUMSTONE GRAVITY EXTENDER WALL CHARTS

RETAINING SOIL 30° | 250 PSF [12kN/M²]

SHEET CONTENT

305

1102-MS-GVT

SHEET REFERENCE

GENERAL NOTES:

These drawings are intended solely to act as an aid when designing a wall. This drawing should not be used for final design or construction.

Each site-specific wall should be certified and signed by a registered geotechnical engineer in the State or Province that it is being built. The accuracy and use of the details in this document are the sole responsibility of the user.

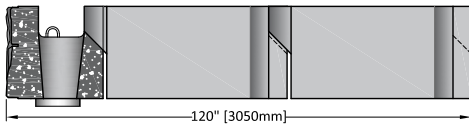
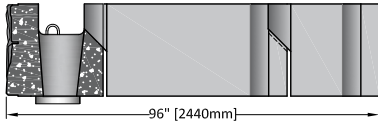
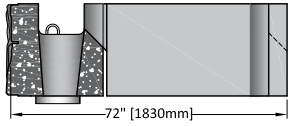
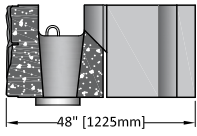

DESCRIPTION

<p>SLOPE ANGLE</p> <p>LIVE LOAD</p> <p>RETAINED SOIL</p> <p>FOUNDATION</p> <p>INFILL SELECT FILL</p> <p>LEVELING PAD</p>	<p>0°</p> <p>250 PSF</p> <p>30°</p> <p>30°</p> <p>30°</p> <p>CRUSHED GRAVEL</p>
--	--

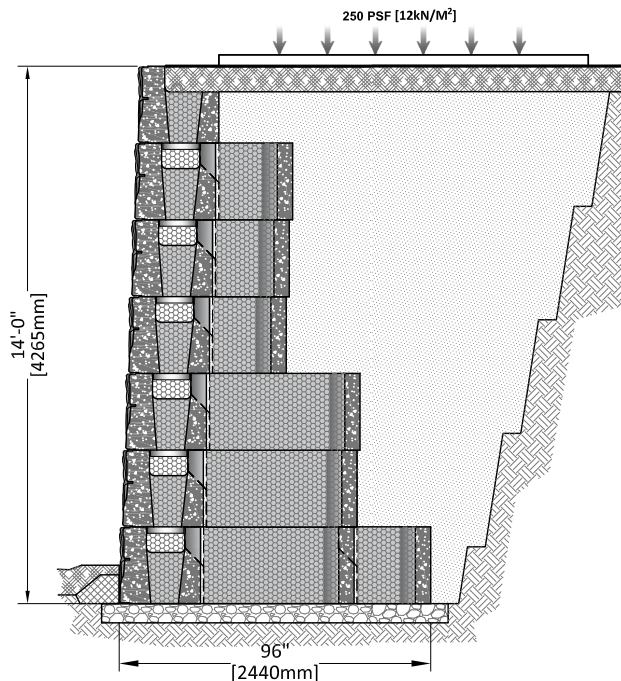
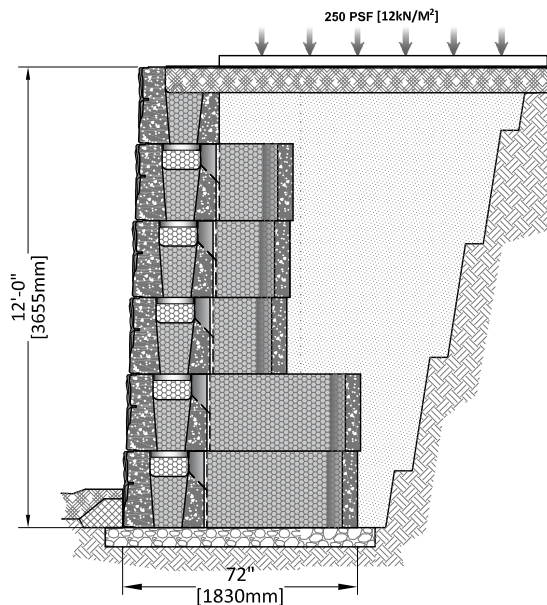
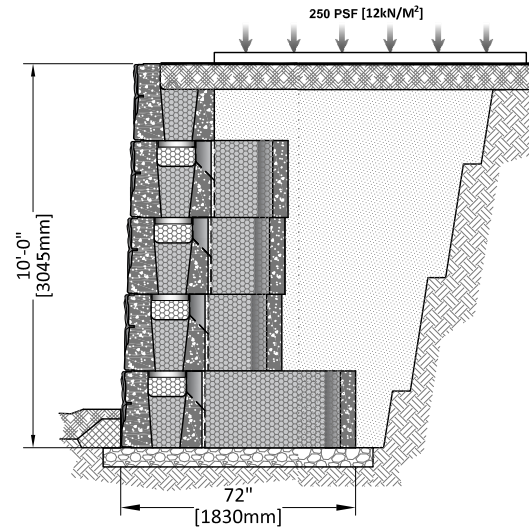
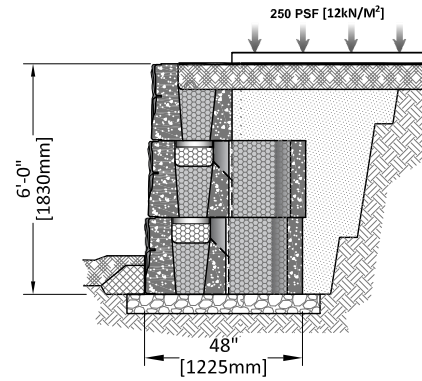
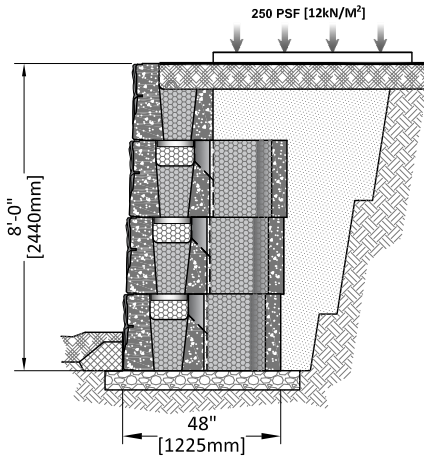



MagnumStone
RETAINING WALLS

www.magnumstone.com | 1 (800) 939-9193

MAGNUMSTONE GRAVITY EXTENDER WALL CHARTS

RETAINING SOIL 28° | 250 PSF [12kN/M²]

SHEET CONTENT

306

1102-MS-GVT

SHEET REFERENCE

GENERAL NOTES:

These drawings are intended solely to act as an aid when designing a wall. This drawing should not be used for final design or construction. Each site-specific wall should be certified and signed by a registered geotechnical engineer in the State or Province that it is being built. The accuracy and use of the details in this document are the sole responsibility of the user.

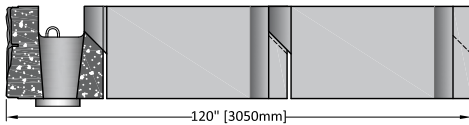
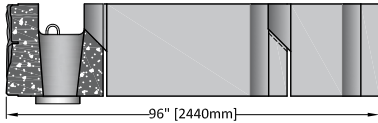
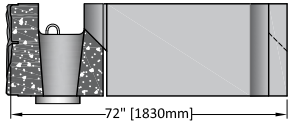
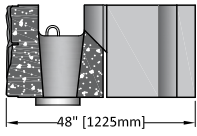

DESCRIPTION

SLOPE ANGLE	0°
LIVE LOAD	250 PSF
RETAINED SOIL	28°
FOUNDATION	28°
INFILL SELECT FILL	28°
LEVELING PAD	CRUSHED GRAVEL

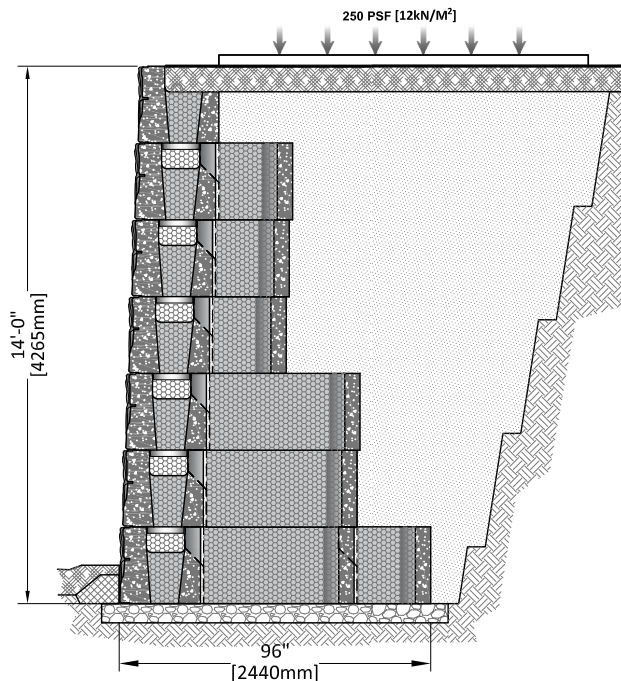
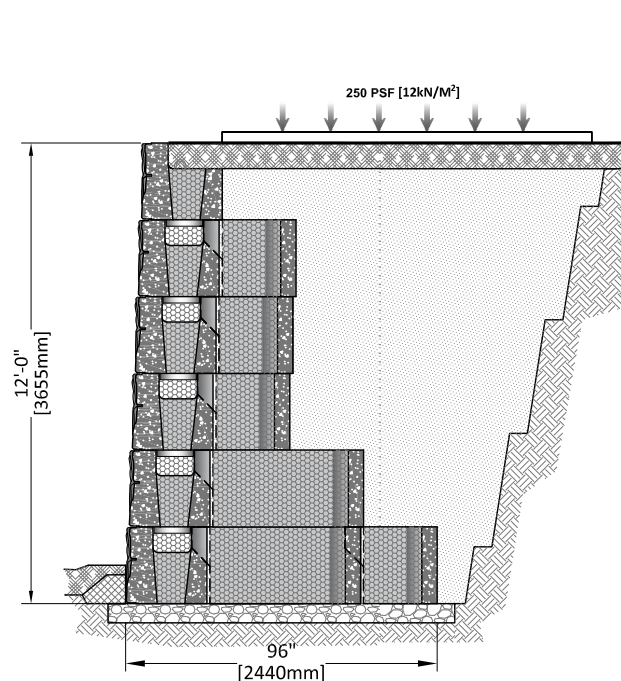
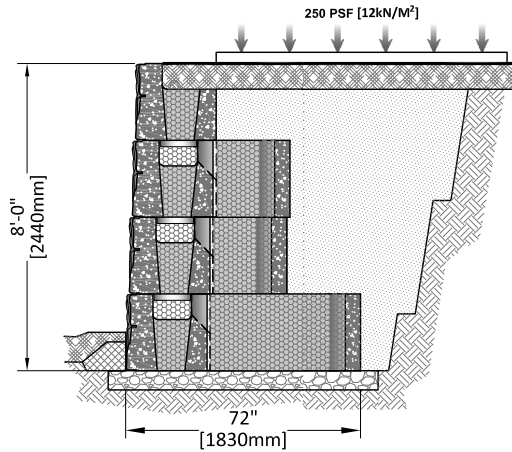
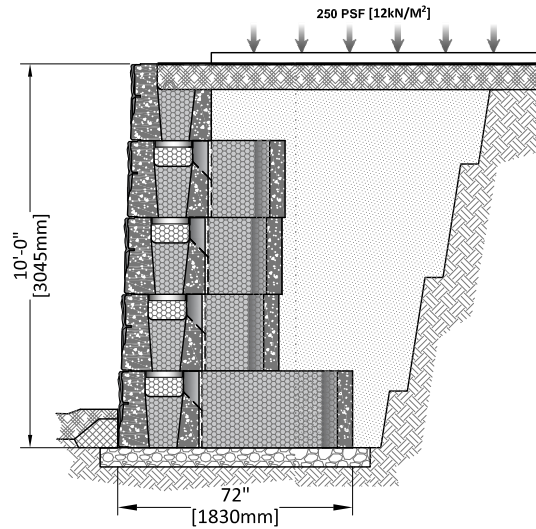
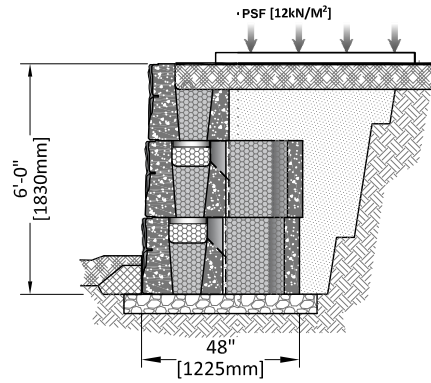



MagnumStone
RETAINING WALLS

www.magnumstone.com | 1 (800) 939-9193

**MAGNUMSTONE
GRAVITY EXTENDER WALL CHARTS
SELECT FILL 28° RETAINED SOIL |
3H:1V BACKSLOPE**

SHEET CONTENT

307

1102-MS-GVT

SHEET REFERENCE

GENERAL NOTES:

These drawings are intended solely to act as an aid when designing a wall. This drawing should not be used for final design or construction. Each site-specific wall should be certified and signed by a registered geotechnical engineer in the State or Province that it is being built. The accuracy and use of the details in this document are the sole responsibility of the user.

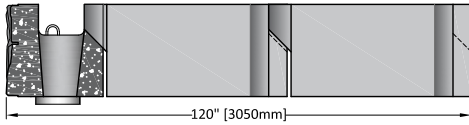
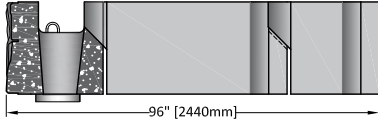
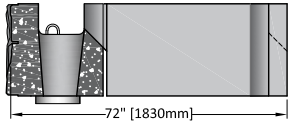
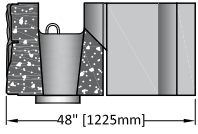

DESCRIPTION

SLOPE ANGLE	18.4° (3H:1V)
LIVE LOAD	0 PSF
RETAINED SOIL	28°
FOUNDATION	28°
INFILL SELECT FILL	34°
LEVELING PAD	CRUSHED GRAVEL

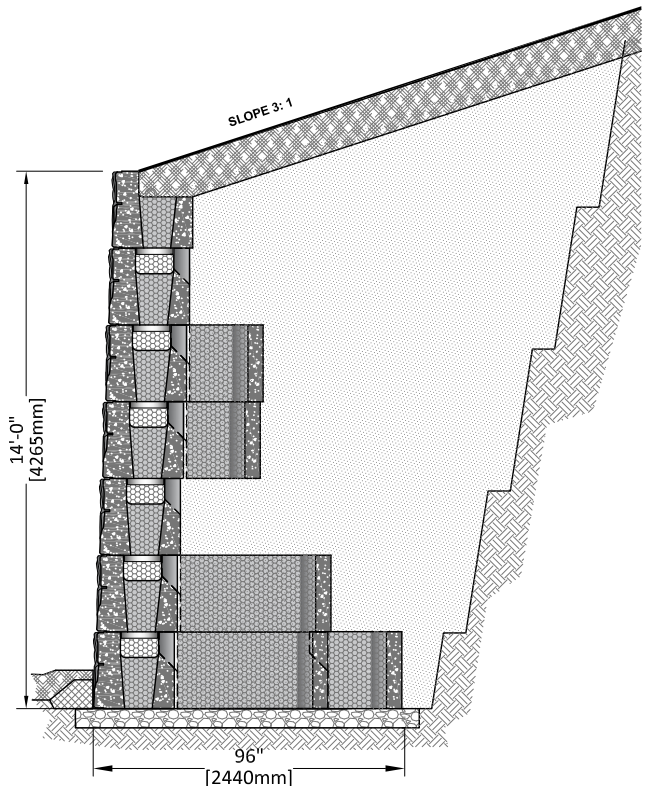
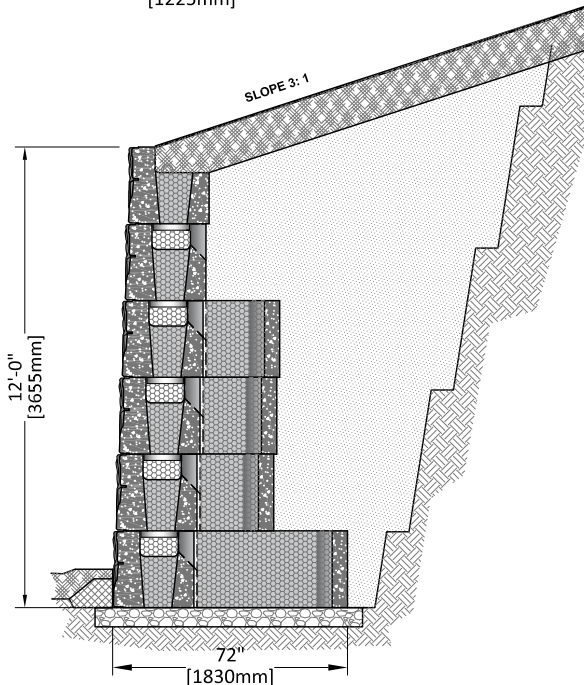
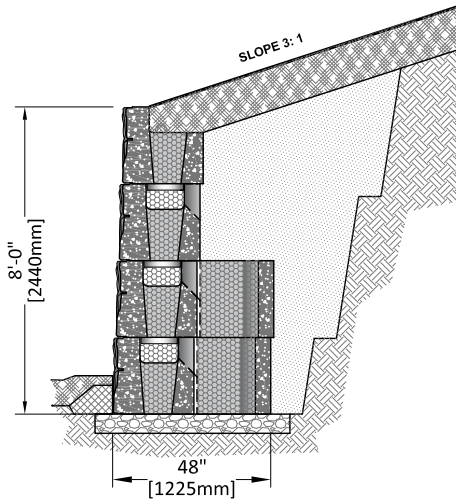
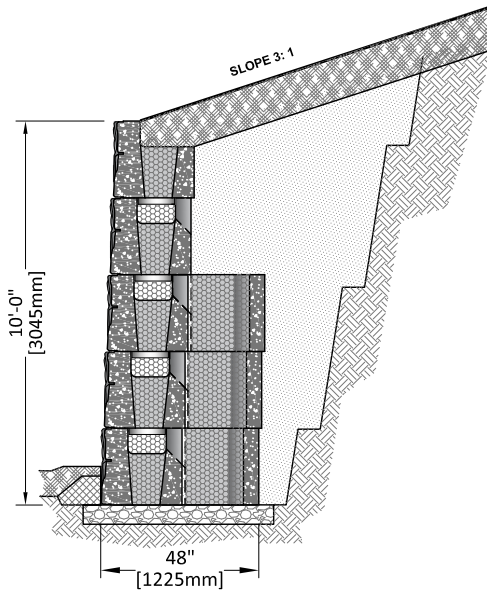
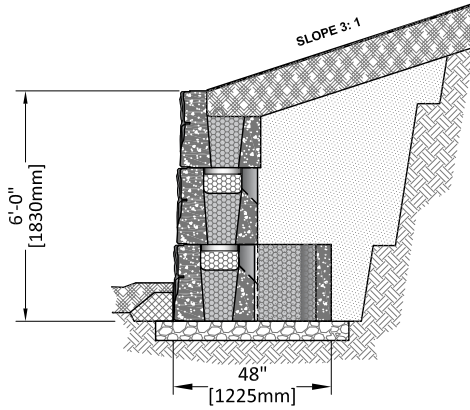



MagnumStone
RETAINING WALLS

www.magnumstone.com | 1 (800) 939-9193

**MAGNUMSTONE
GRAVITY EXTENDER WALL CHARTS
RETAINING SOIL 30° | 3H:1V BACKSLOPE**

SHEET CONTENT

308

1102-MS-GVT

SHEET REFERENCE

GENERAL NOTES:

These drawings are intended solely to act as an aid when designing a wall. This drawing should not be used for final design or construction. Each site-specific wall should be certified and signed by a registered geotechnical engineer in the State or Province that it is being built. The accuracy and use of the details in this document are the sole responsibility of the user.

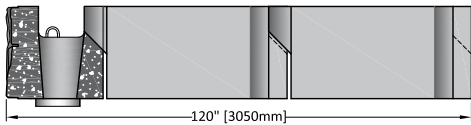
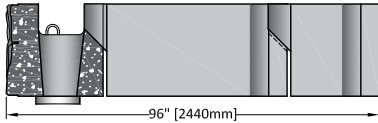
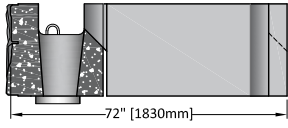
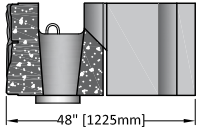

DESCRIPTION

SLOPE ANGLE	18.4° (3H:1V)
LIVE LOAD	0 PSF
RETAINED SOIL	30°
FOUNDATION	30°
INFILL SELECT FILL	30°
LEVELING PAD	CRUSHED GRAVEL

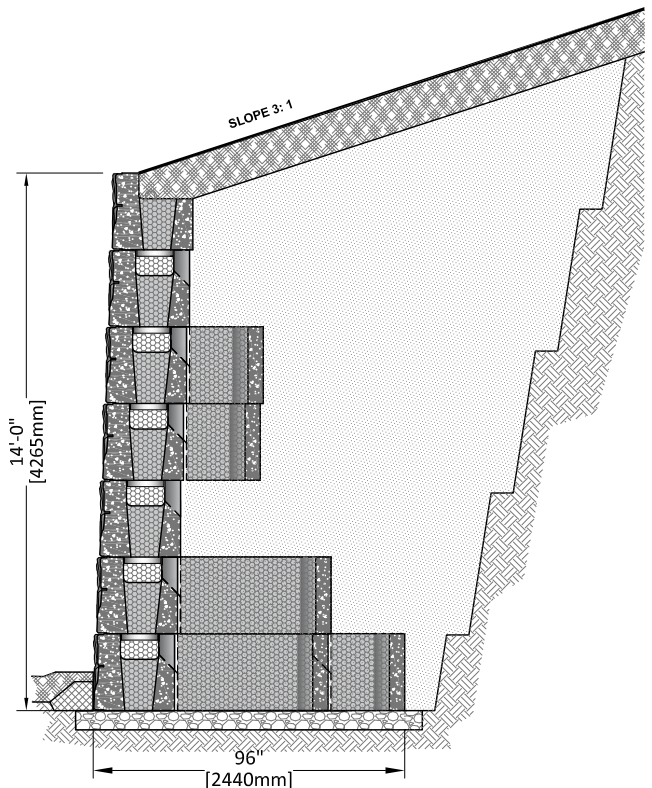
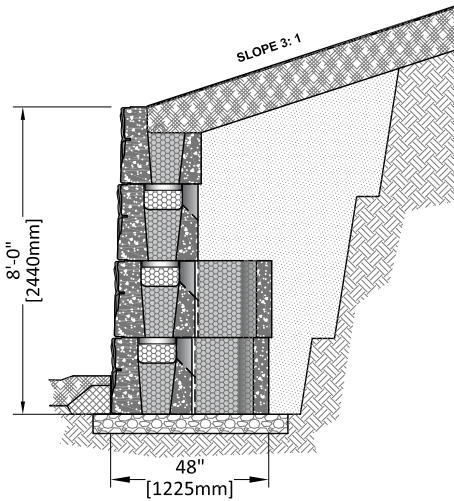
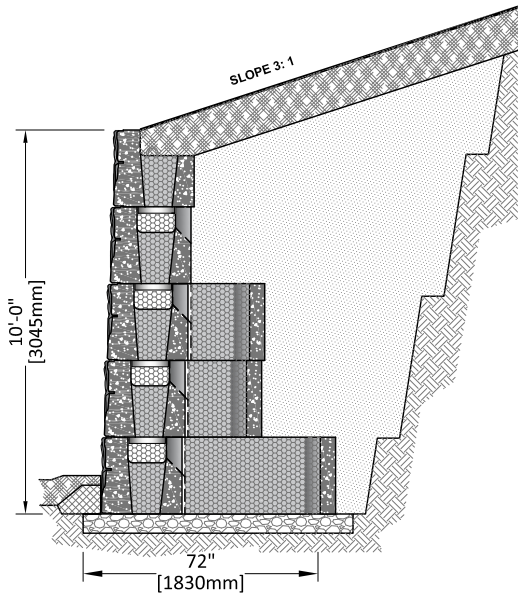
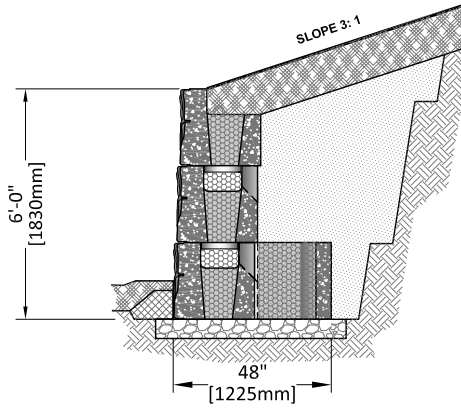



MagnumStone
RETAINING WALLS

www.magnumstone.com | 1 (800) 939-9193

**MAGNUMSTONE
GRAVITY EXTENDER WALL CHARTS
RETAINING SOIL 28° | 3H:1V BACKSLOPE**

SHEET CONTENT

309

1102-MS-GVT

SHEET REFERENCE

GENERAL NOTES:

These drawings are intended solely to act as an aid when designing a wall. This drawing should not be used for final design or construction. Each site-specific wall should be certified and signed by a registered geotechnical engineer in the State or Province that it is being built. The accuracy and use of the details in this document are the sole responsibility of the user.

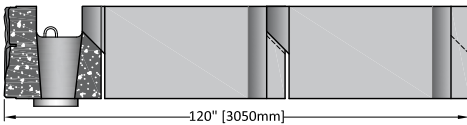
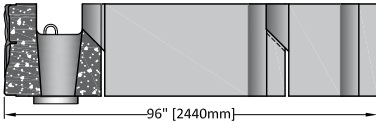
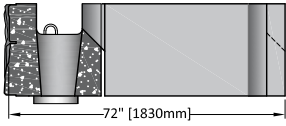
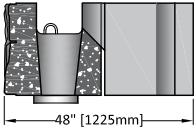

DESCRIPTION

SLOPE ANGLE	18.4° (3H:1V)
LIVE LOAD	0 PSF
RETAINED SOIL	28°
FOUNDATION	28°
INFILL SELECT FILL	28°
LEVELING PAD	CRUSHED GRAVEL

