



MagnumStone
RETAINING WALLS

www.magnumstone.com | 1 (800) 939-9193

MAGNUMSTONE GEOGRID WALL CHARTS

SHEET CONTENT

300

1101-MS-GEO

SHEET REFERENCE

GENERAL NOTES:

These drawings are intended solely to act as an aid when designing a wall. This drawing should not be used for final design or construction. Each site-specific wall should be certified and signed by a registered geotechnical engineer in the State or Province that it is being built. The accuracy and use of the details in this document are the sole responsibility of the user.

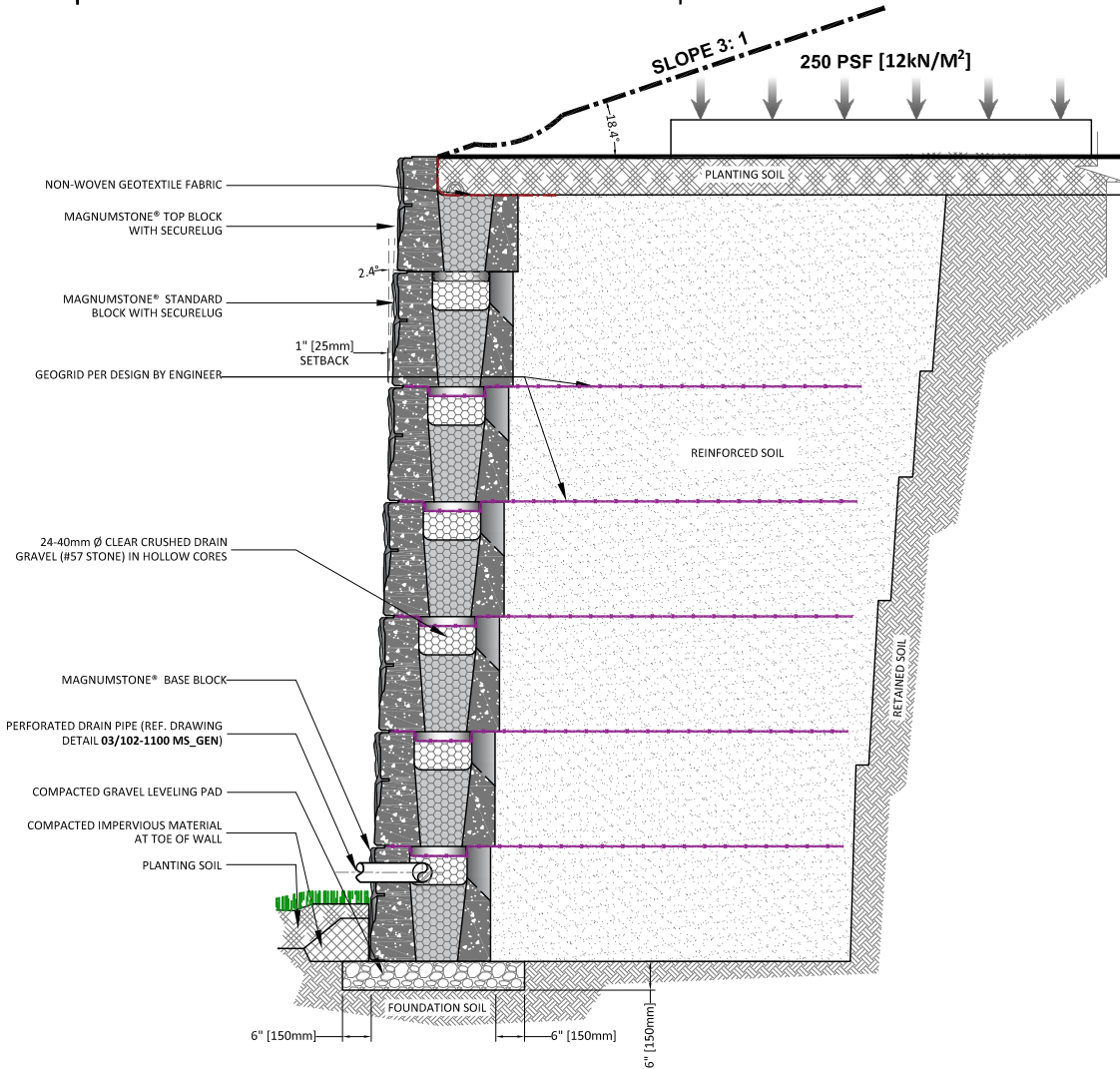

GEOGRID WALL TYPICAL CROSS SECTION

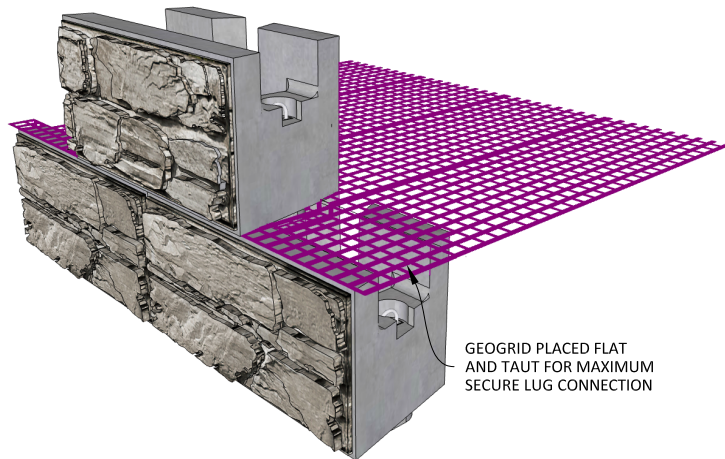

ISOMETRIC VIEW

GENERAL NOTE:
FOLLOW PROPER INSTALLATION GUIDELINE AS PER THE MAGNUMSTONE® INSTALLATION MANUAL. ENSURE LOCAL CODES AND GUIDELINES ARE ALWAYS BEING FOLLOWED



MagnumStone
RETAINING WALLS

www.magnumstone.com | 1 (800) 939-9193

**MAGNUMSTONE
GEOGRID WALL CHARTS**

RETAINING SOIL 26° | NO LOAD

SHEET CONTENT

DESCRIPTION

SLOPE ANGLE	0°
LIVE LOAD	0 PSF
RETAINED SOIL	26°
FOUNDATION	26°
REINFORCED SOIL	26°
LEVELING PAD	CRUSHED GRAVEL

GENERAL NOTES:

These drawings are intended solely to act as an aid when designing a wall. This drawing should not be used for final design or construction. Each site-specific wall should be certified and signed by a registered geotechnical engineer in the State or Province that it is being built. The accuracy and use of the details in this document are the sole responsibility of the user.

301

1101-MS-GEO

SHEET REFERENCE

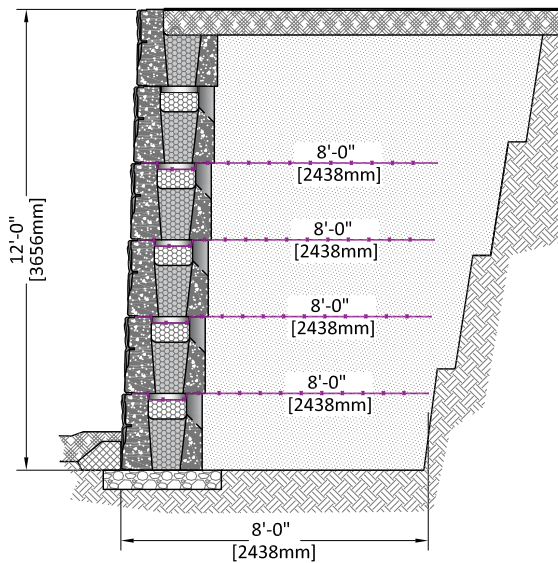
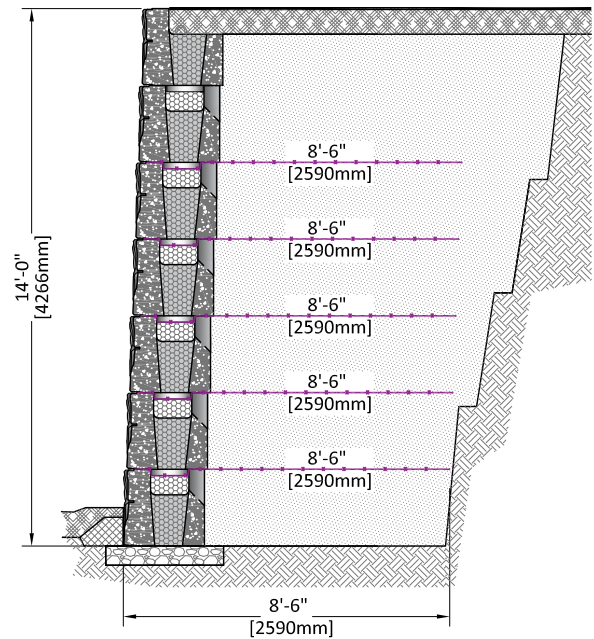
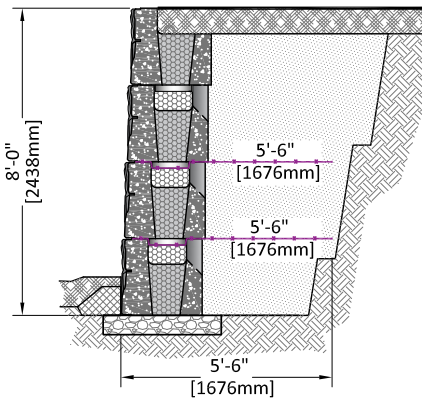
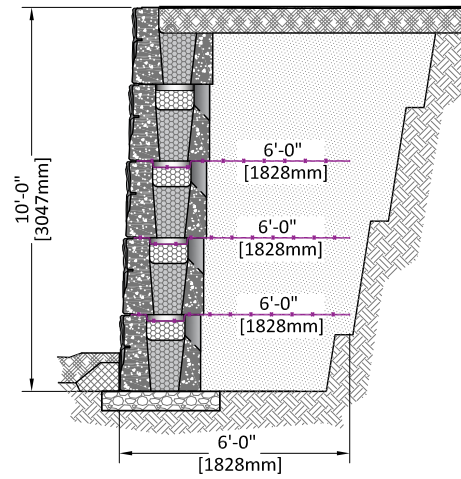
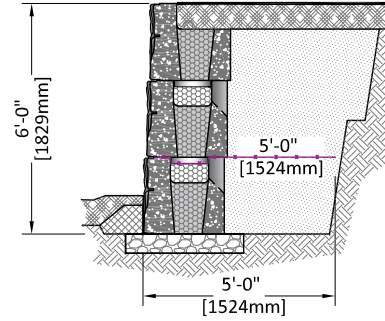



MagnumStone
RETAINING WALLS

www.magnumstone.com | 1 (800) 939-9193

**MAGNUMSTONE
GEOGRID WALL CHARTS**

RETAINING SOIL 28° | NO LOAD

SHEET CONTENT

GENERAL NOTES:

These drawings are intended solely to act as an aid when designing a wall. This drawing should not be used for final design or construction. Each site-specific wall should be certified and signed by a registered geotechnical engineer in the State or Province that it is being built. The accuracy and use of the details in this document are the sole responsibility of the user.

302

1101-MS-GEO

SHEET REFERENCE

DESCRIPTION

SLOPE ANGLE	0°
LIVE LOAD	0 PSF
RETAINED SOIL	28°
FOUNDATION	28°
REINFORCED SOIL	28°
LEVELING PAD	CRUSHED GRAVEL

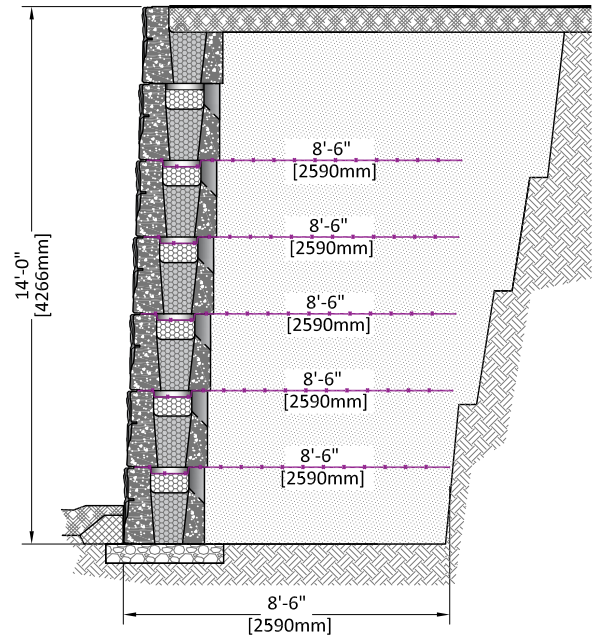
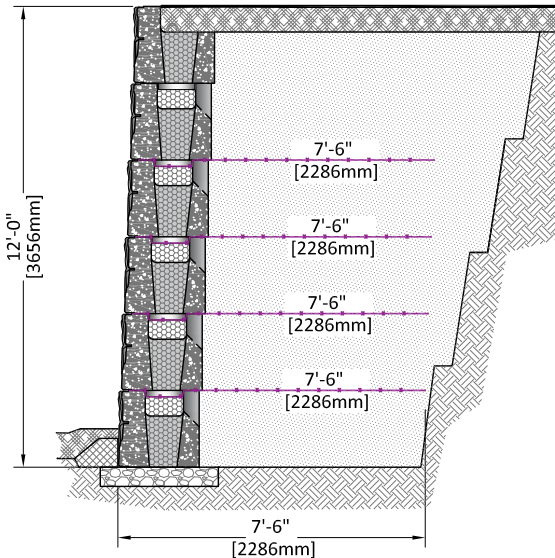
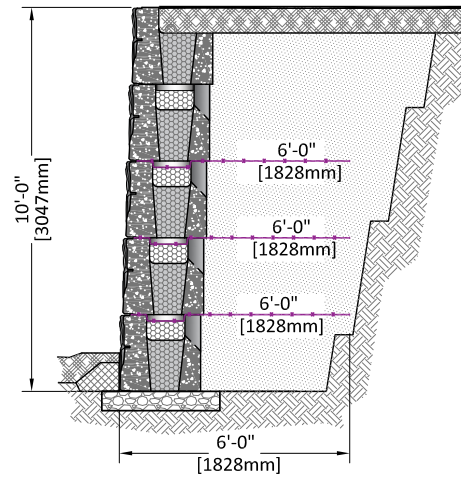
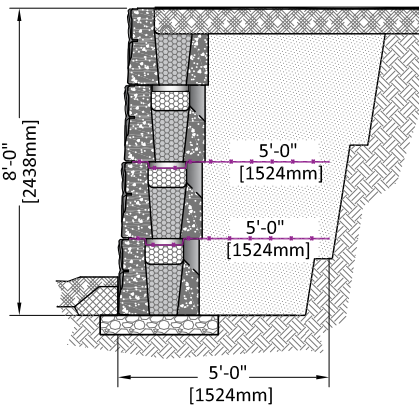
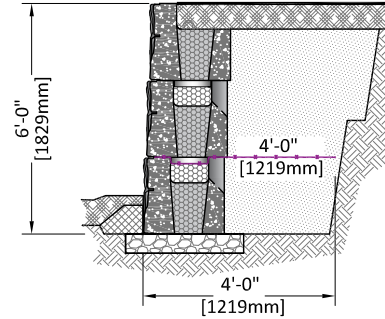



MagnumStone
RETAINING WALLS

www.magnumstone.com | 1 (800) 939-9193

**MAGNUMSTONE
GEOGRID WALL CHARTS**

RETAINING SOIL 30° | NO LOAD

SHEET CONTENT

GENERAL NOTES:

These drawings are intended solely to act as an aid when designing a wall. This drawing should not be used for final design or construction.

Each site-specific wall should be certified and signed by a registered geotechnical engineer in the State or Province that it is being built. The accuracy and use of the details in this document are the sole responsibility of the user.

303

1101-MS-GEO

SHEET REFERENCE

DESCRIPTION

SLOPE ANGLE	0°
LIVE LOAD	0 PSF
RETAINED SOIL	30°
FOUNDATION	30°
REINFORCED SOIL	30°
LEVELING PAD	CRUSHED GRAVEL

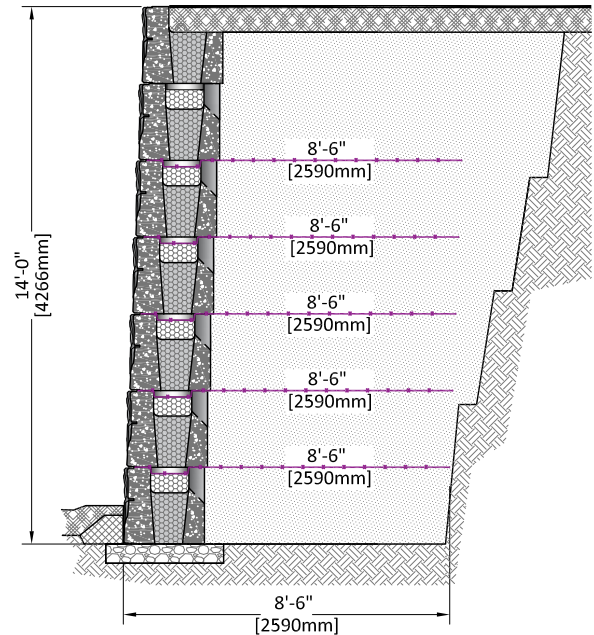
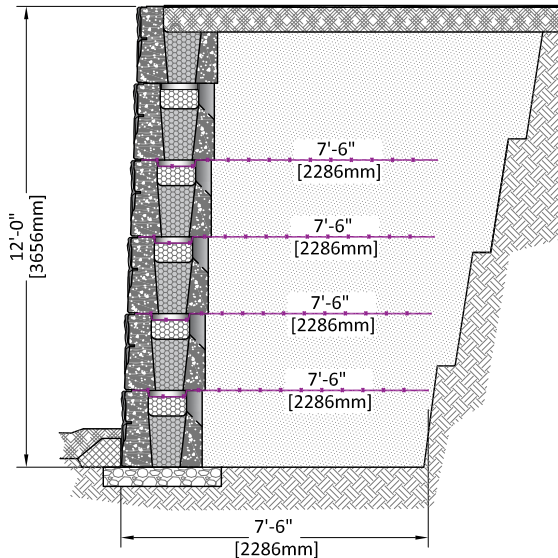
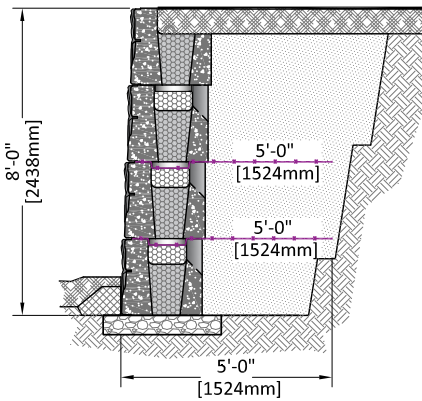
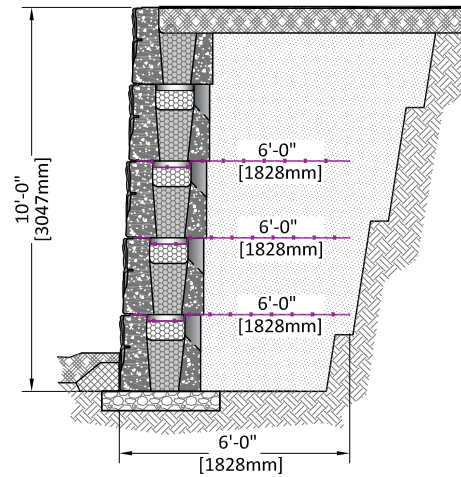
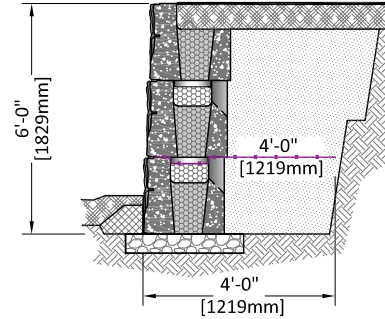



MagnumStone
RETAINING WALLS

www.magnumstone.com | 1 (800) 939-9193

**MAGNUMSTONE
GEOGRID WALL CHARTS**

RETAINED SOIL 26° | 250 PSF [12kN/M²]

SHEET CONTENT

304

1101-MS-GEO

SHEET REFERENCE

GENERAL NOTES:

These drawings are intended solely to act as an aid when designing a wall. This drawing should not be used for final design or construction. Each site-specific wall should be certified and signed by a registered geotechnical engineer in the State or Province that it is being built. The accuracy and use of the details in this document are the sole responsibility of the user.

DESCRIPTION

SLOPE ANGLE	0°
LIVE LOAD	250 PSF
RETAINED SOIL	26°
FOUNDATION	26°
REINFORCED SOIL	26°
LEVELING PAD	CRUSHED GRAVEL

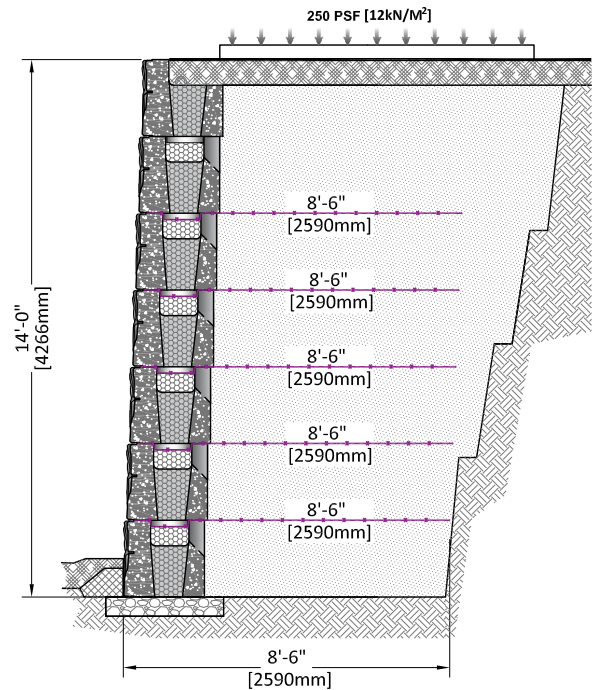
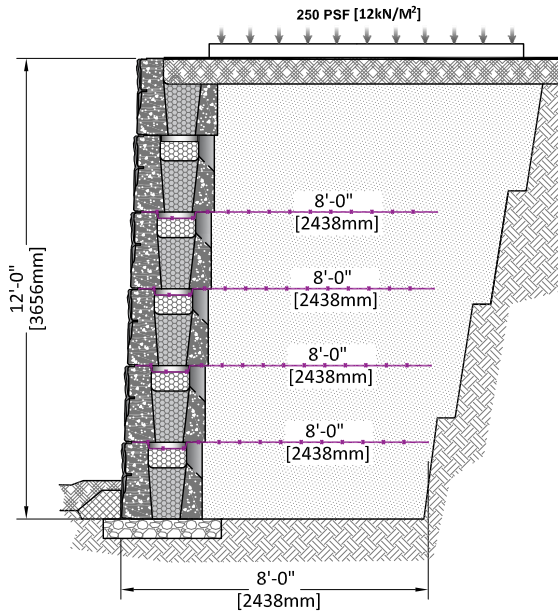
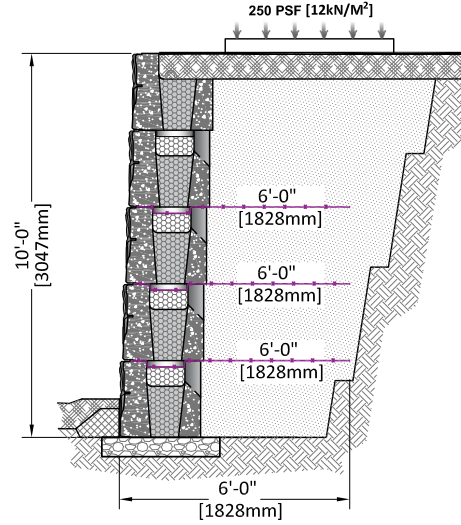
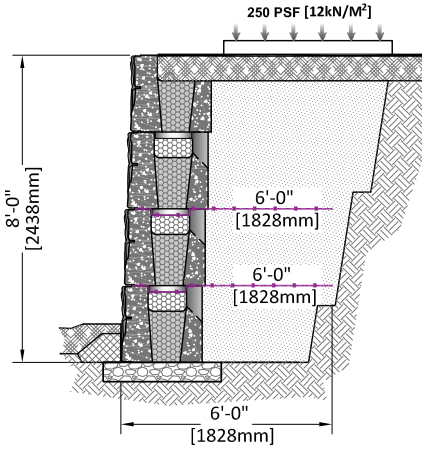
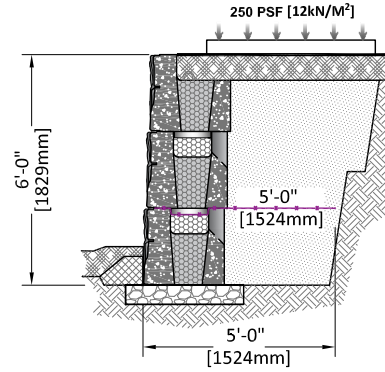



MagnumStone
RETAINING WALLS

www.magnumstone.com | 1 (800) 939-9193

MAGNUMSTONE GEOGRID WALL CHARTS

RETAINED SOIL 28° | 250 PSF [12kN/M²]

SHEET CONTENT

DESCRIPTION

SLOPE ANGLE	0°
LIVE LOAD	250 PSF
RETAINED SOIL	28°
FOUNDATION	28°
REINFORCED SOIL	28°
LEVELING PAD	CRUSHED GRAVEL

GENERAL NOTES:

These drawings are intended solely to act as an aid when designing a wall. This drawing should not be used for final design or construction. Each site-specific wall should be certified and signed by a registered geotechnical engineer in the State or Province that it is being built. The accuracy and use of the details in this document are the sole responsibility of the user.

305

1101-MS-GEO

SHEET REFERENCE

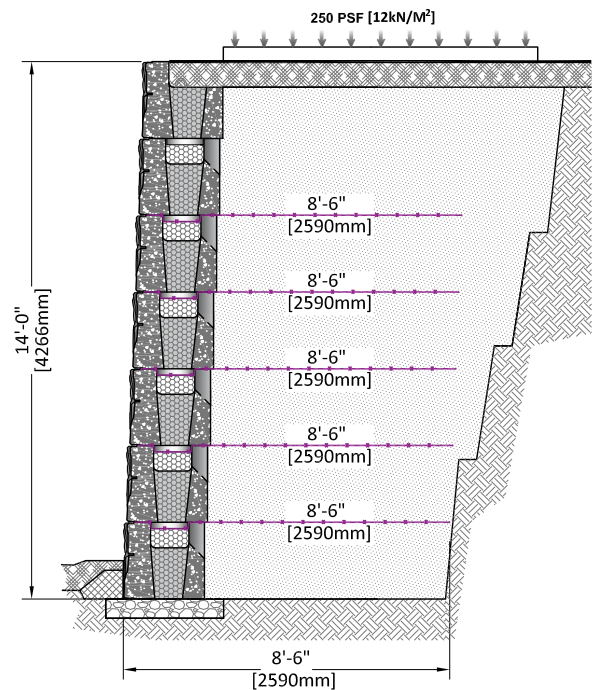
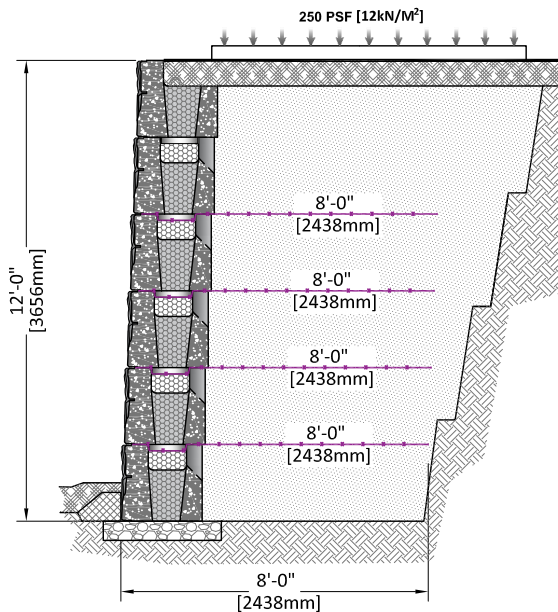
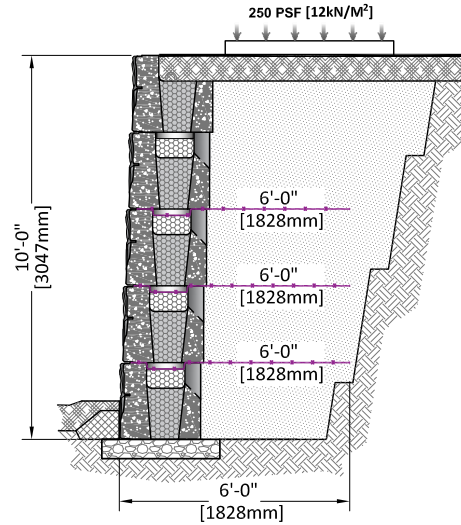
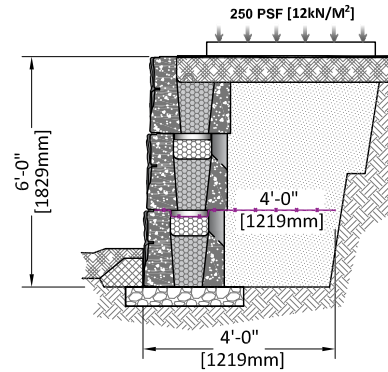
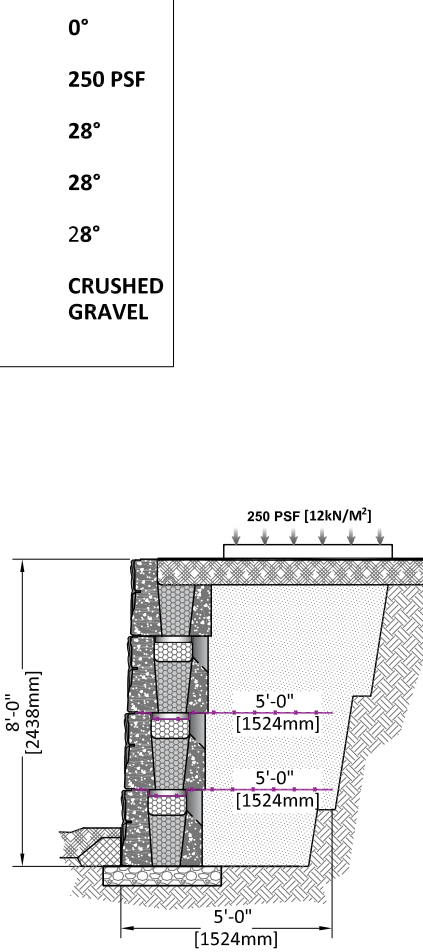



MagnumStone
RETAINING WALLS

www.magnumstone.com | 1 (800) 939-9193

**MAGNUMSTONE
GEOGRID WALL CHARTS**

RETAINING SOIL 30° | 250 PSF [12kN/M²]

SHEET CONTENT

306

1101-MS-GEO

SHEET REFERENCE

GENERAL NOTES:

These drawings are intended solely to act as an aid when designing a wall. This drawing should not be used for final design or construction. Each site-specific wall should be certified and signed by a registered geotechnical engineer in the State or Province that it is being built. The accuracy and use of the details in this document are the sole responsibility of the user.

DESCRIPTION

SLOPE ANGLE	0°
LIVE LOAD	250 PSF
RETAINED SOIL	30°
FOUNDATION	30°
REINFORCED SOIL	30°
LEVELING PAD	CRUSHED GRAVEL

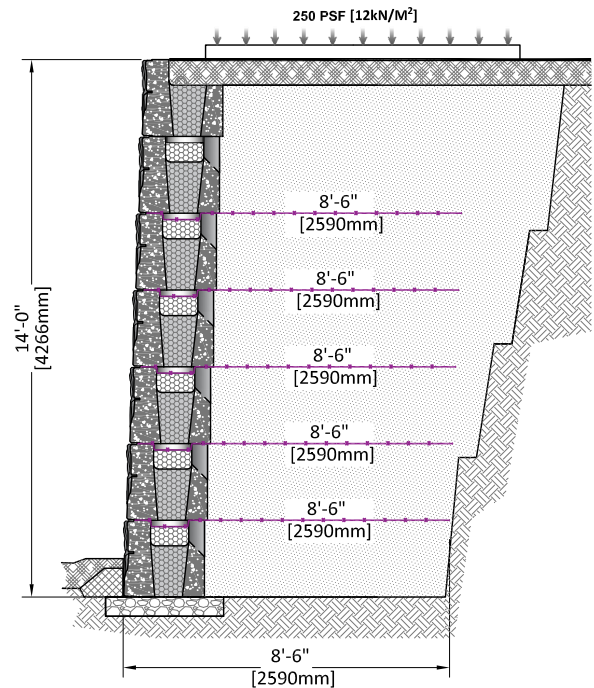
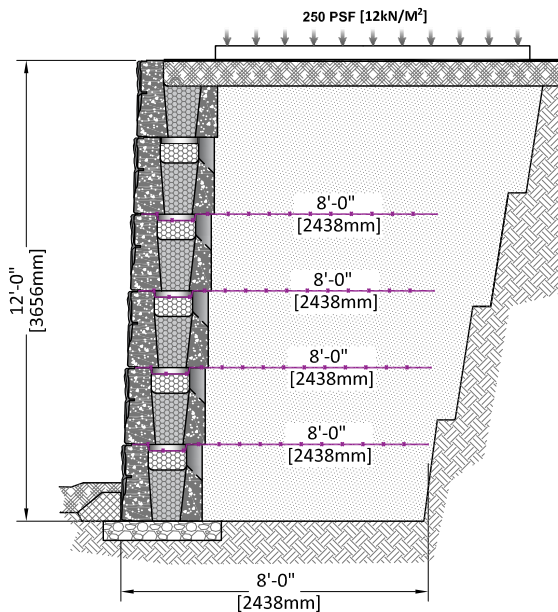
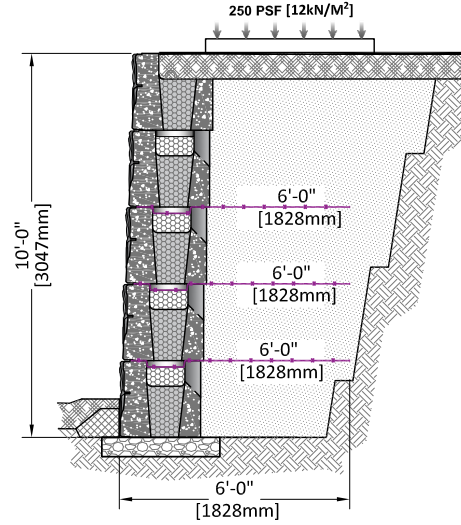
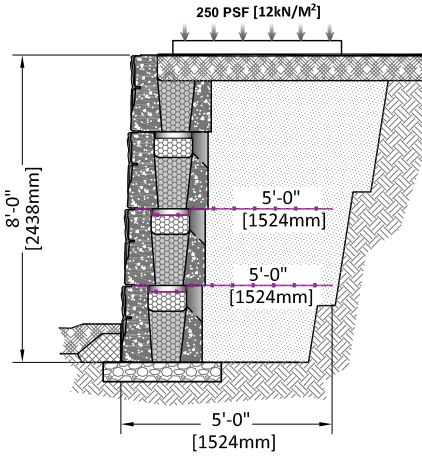
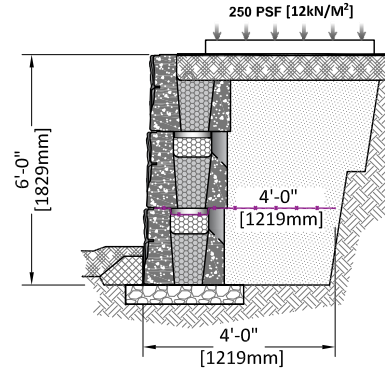



MagnumStone
RETAINING WALLS

www.magnumstone.com | 1 (800) 939-9193

MAGNUMSTONE GEOGRID WALL CHARTS

RETAINING SOIL 26° | 3H:1V BACKSLOPE

SHEET CONTENT

307

1101-MS-GEO

SHEET REFERENCE

GENERAL NOTES:

These drawings are intended solely to act as an aid when designing a wall. This drawing should not be used for final design or construction. Each site-specific wall should be certified and signed by a registered geotechnical engineer in the State or Province that it is being built. The accuracy and use of the details in this document are the sole responsibility of the user.

DESCRIPTION

SLOPE ANGLE	18.4° (3H:1V)
LIVE LOAD	0 PSF
RETAINED SOIL	28°
FOUNDATION	28°
REINFORCED SOIL	34°
LEVELING PAD	CRUSHED GRAVEL

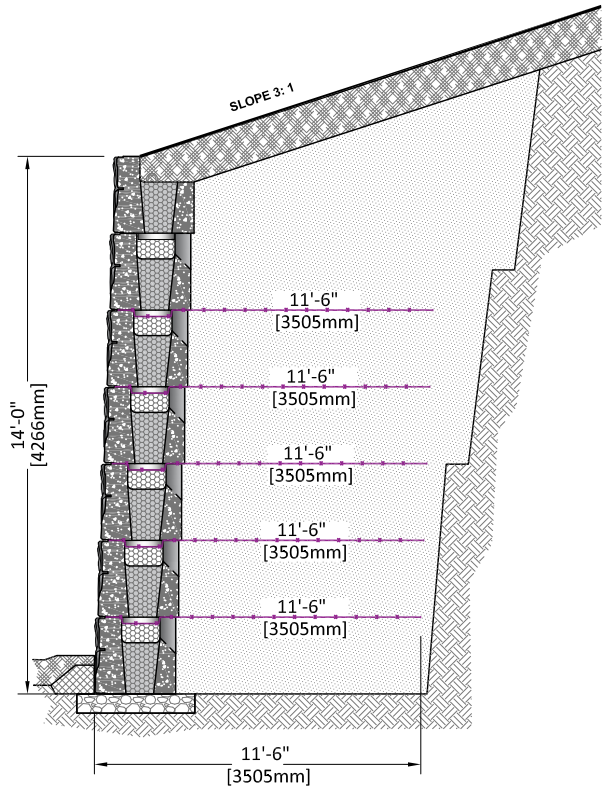
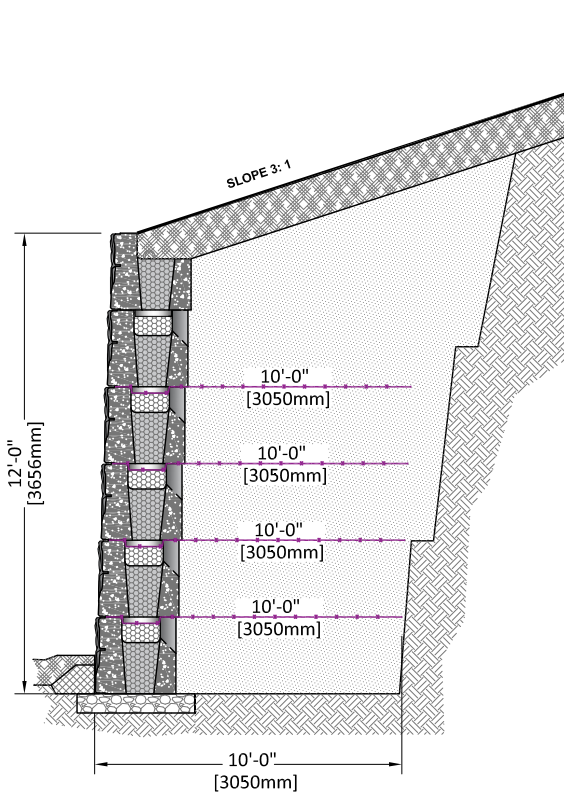
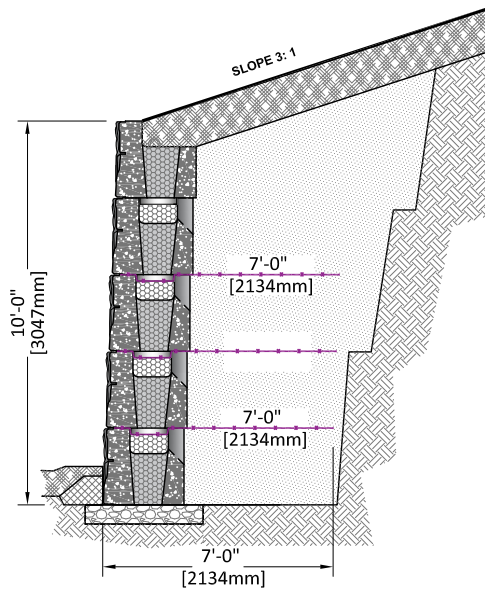
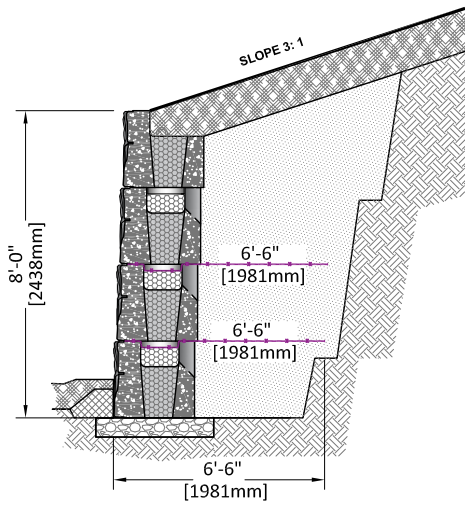
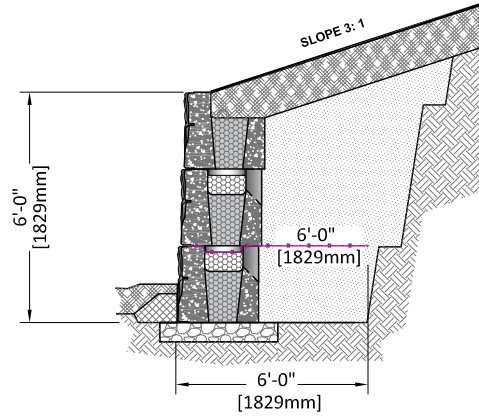



MagnumStone
RETAINING WALLS

www.magnumstone.com | 1 (800) 939-9193

MAGNUMSTONE GEOGRID WALL CHARTS

RETAINING SOIL 28° | 3H:1V BACKSLOPE

SHEET CONTENT

308

1101-MS-GEO

SHEET REFERENCE

GENERAL NOTES:

These drawings are intended solely to act as an aid when designing a wall. This drawing should not be used for final design or construction. Each site-specific wall should be certified and signed by a registered geotechnical engineer in the State or Province that it is being built. The accuracy and use of the details in this document are the sole responsibility of the user.

DESCRIPTION

SLOPE ANGLE	18.4° (3H:1V)
LIVE LOAD	0 PSF
RETAINED SOIL	28°
FOUNDATION	28°
REINFORCED SOIL	28°
LEVELING PAD	CRUSHED GRAVEL

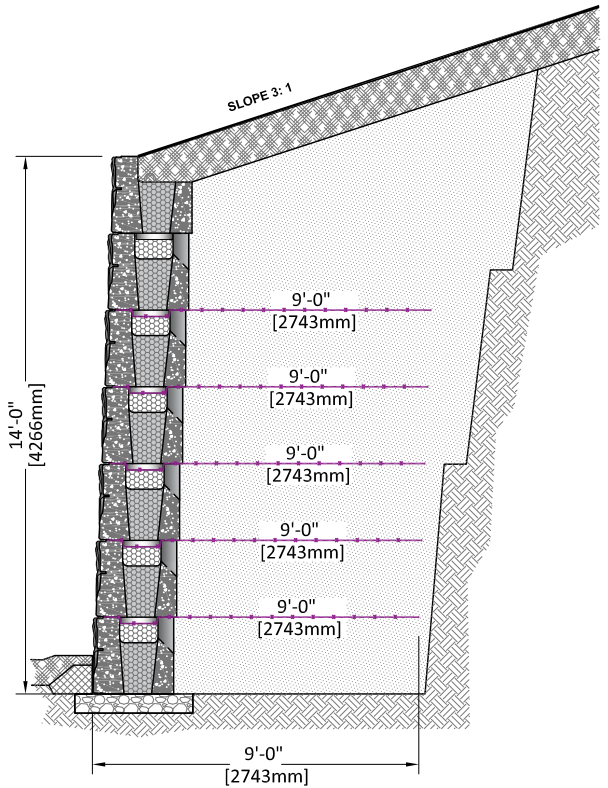
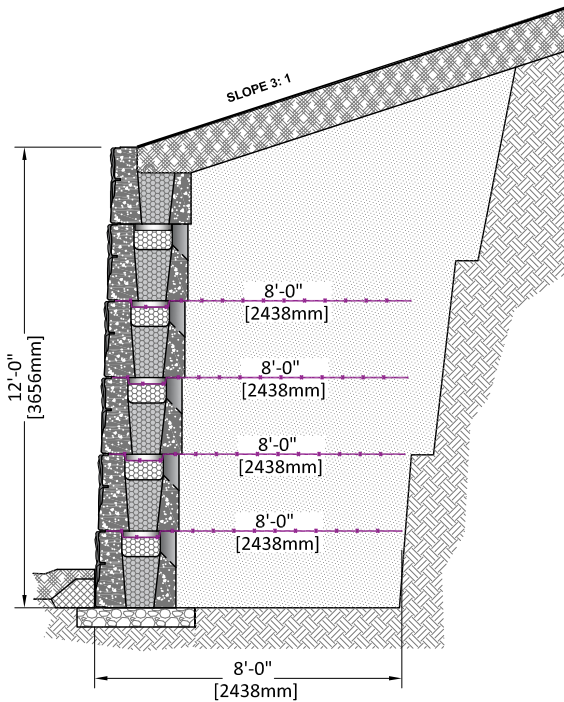
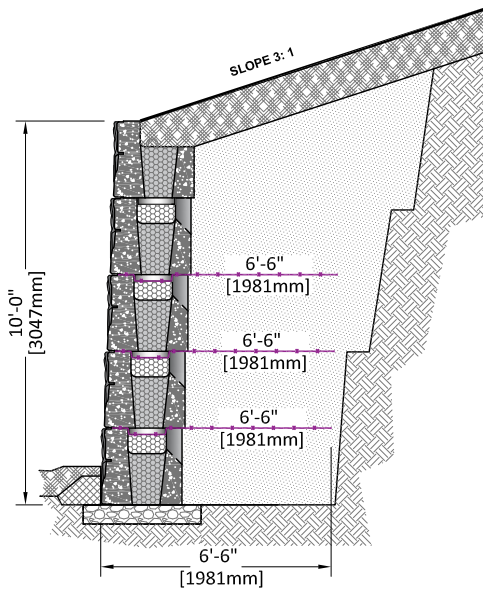
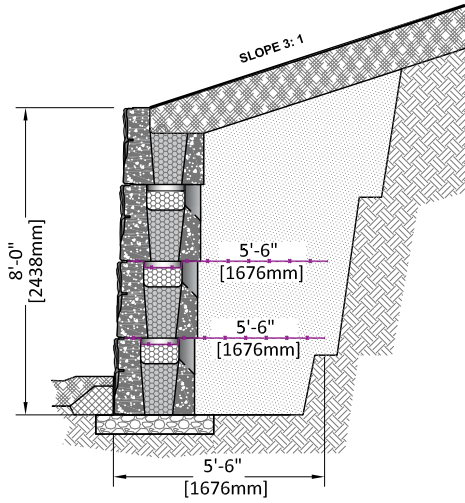
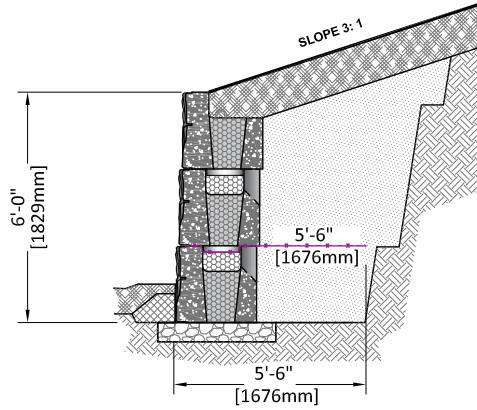



MagnumStone
RETAINING WALLS

www.magnumstone.com | 1 (800) 939-9193

**MAGNUMSTONE
GEOGRID WALL CHARTS**

RETAINING SOIL 30° | 3H:1V BACKSLOPE

SHEET CONTENT

309

1101-MS-GEO

SHEET REFERENCE

GENERAL NOTES:

These drawings are intended solely to act as an aid when designing a wall. This drawing should not be used for final design or construction. Each site-specific wall should be certified and signed by a registered geotechnical engineer in the State or Province that it is being built. The accuracy and use of the details in this document are the sole responsibility of the user.

DESCRIPTION

SLOPE ANGLE	18.4° (3H:1V)
LIVE LOAD	0 PSF
RETAINED SOIL	30°
FOUNDATION	30°
REINFORCED SOIL	30°
LEVELING PAD	CRUSHED GRAVEL

