



MagnumStone
RETAINING WALLS

www.magnumstone.com | 1 (800) 939-9193

MAGNUMSTONE INSIDE CORNER (RIGHT-ANGLED) WALL GENERIC LAYOUT

SHEET CONTENT

101

0102-MS-APX

SHEET REFERENCE

GENERAL NOTES:

These drawings are intended solely to act as an aid when designing a wall. This drawing should not be used for final design or construction.

Each site-specific wall should be certified and signed by a registered geotechnical engineer in the State or Province that it is being built. The accuracy and use of the details in this document are the sole responsibility of the user.

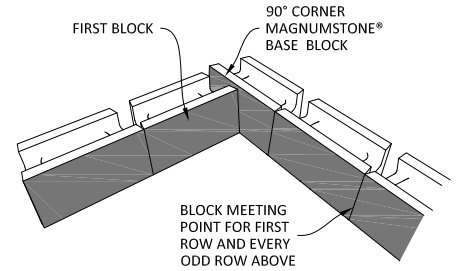
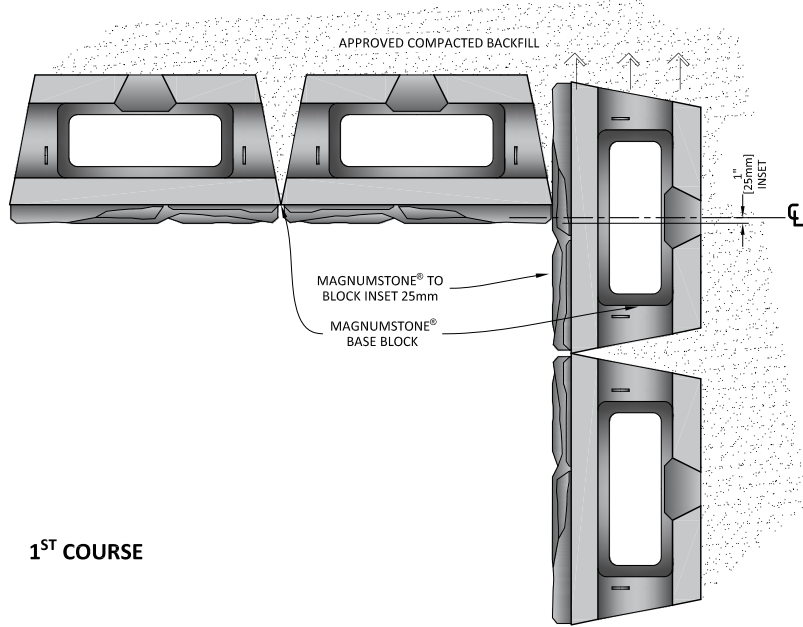

(1ST COURSE)

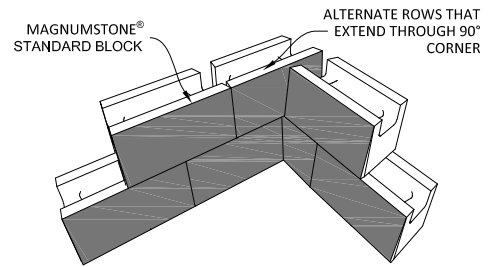

(2ND COURSE)

INSIDE CORNER

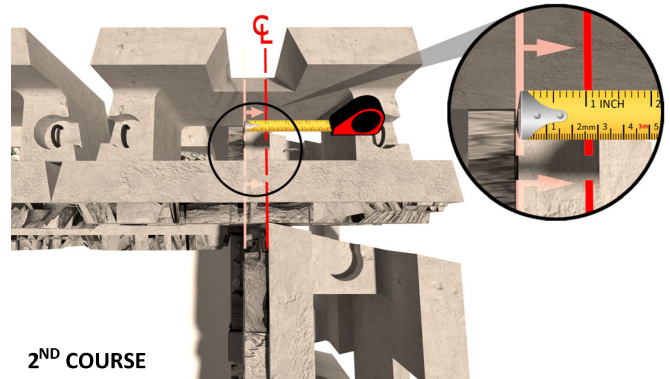
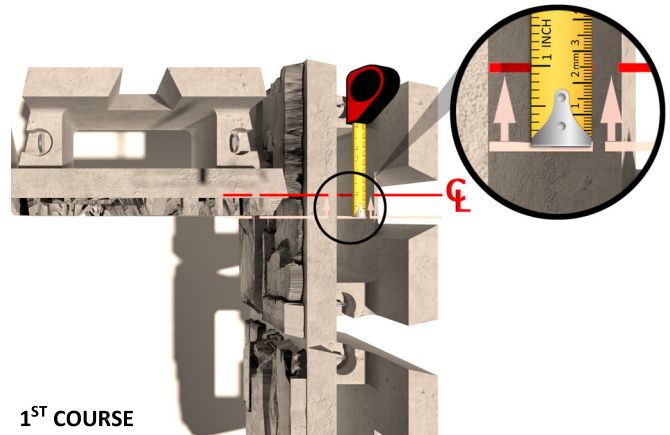
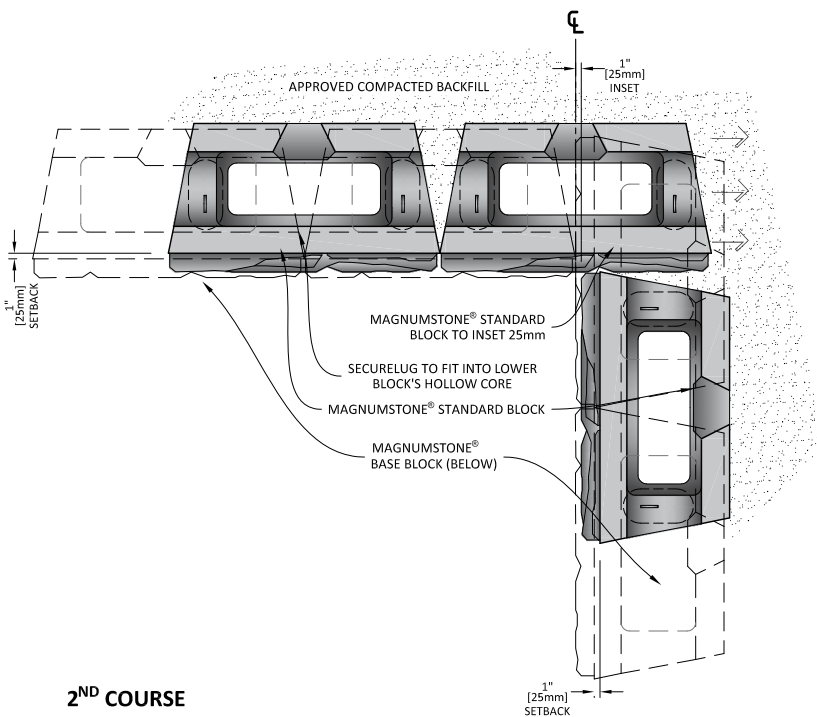

PERSPECTIVE

RIGHT- ANGLED CORNER



MagnumStone
RETAINING WALLS

www.magnumstone.com | 1 (800) 939-9193

MAGNUMSTONE INSIDE CORNER (ODD-ANGLED) WALL GENERIC LAYOUT

SHEET CONTENT

102

0102-MS-APX

SHEET REFERENCE

GENERAL NOTES:

These drawings are intended solely to act as an aid when designing a wall. This drawing should not be used for final design or construction.

Each site-specific wall should be certified and signed by a registered geotechnical engineer in the State or Province that it is being built. The accuracy and use of the details in this document are the sole responsibility of the user.

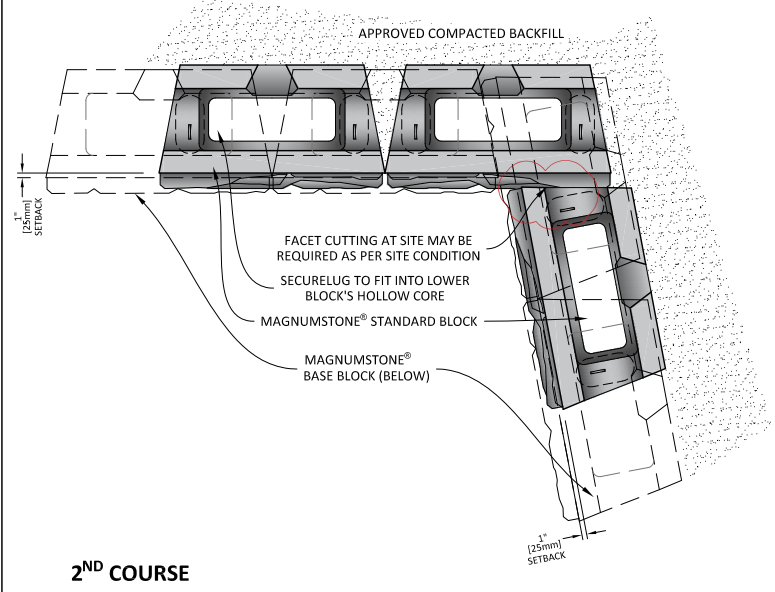
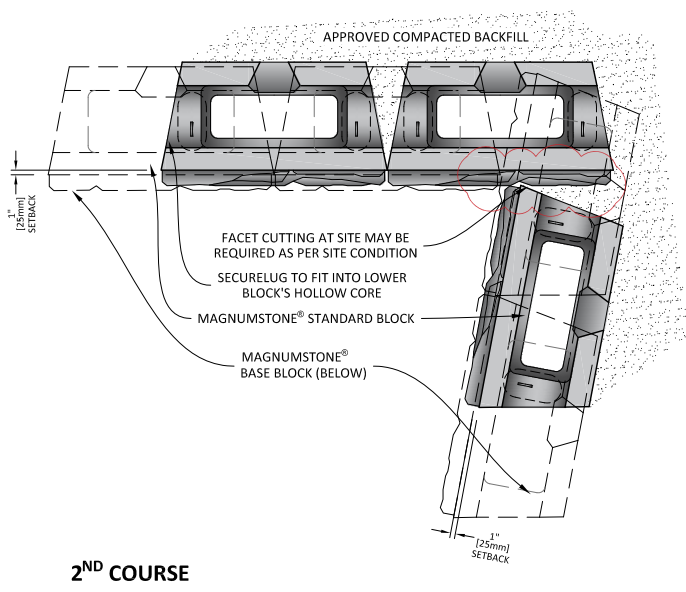
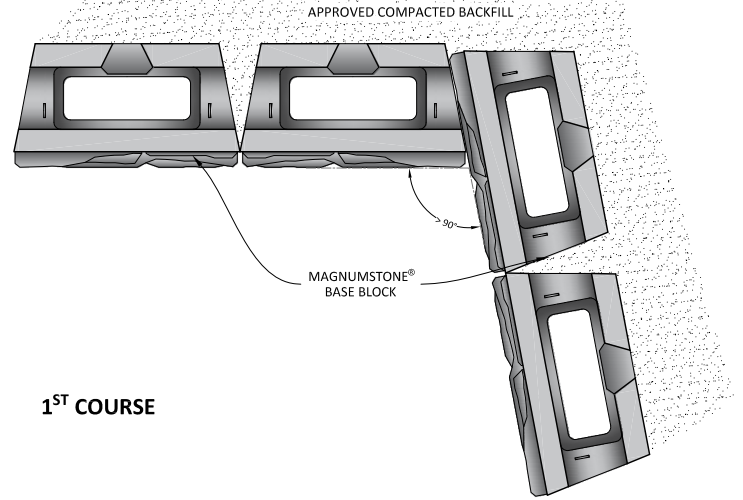
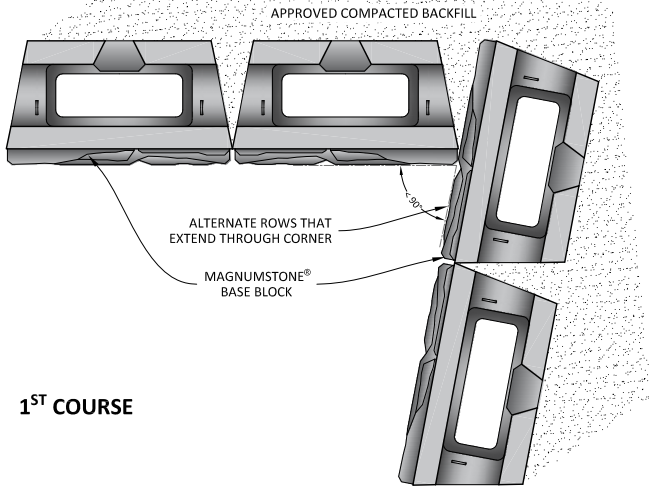

ACUTE- ANGLED CORNER

OBTUSE- ANGLED CORNER



MagnumStone
RETAINING WALLS

www.magnumstone.com | 1 (800) 939-9193

MAGNUMSTONE OUTSIDE CORNER (RIGHT-ANGLED) WALL GENERIC LAYOUT

SHEET CONTENT

103

0102-MS-APX

SHEET REFERENCE

GENERAL NOTES:

These drawings are intended solely to act as an aid when designing a wall. This drawing should not be used for final design or construction.

Each site-specific wall should be certified and signed by a registered geotechnical engineer in the State or Province that it is being built. The accuracy and use of the details in this document are the sole responsibility of the user.

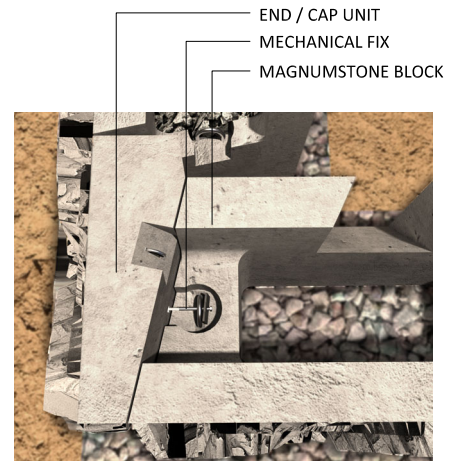
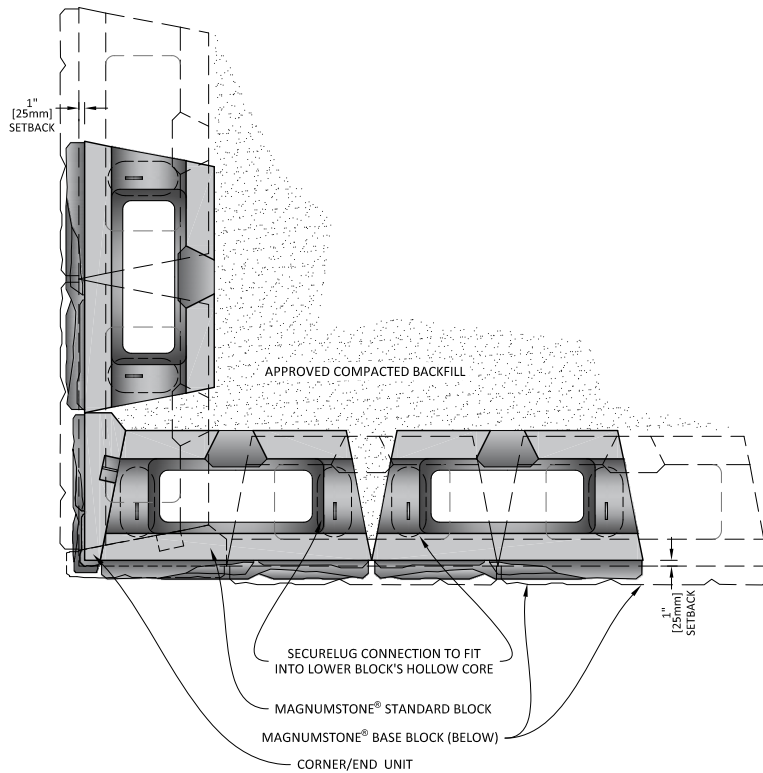
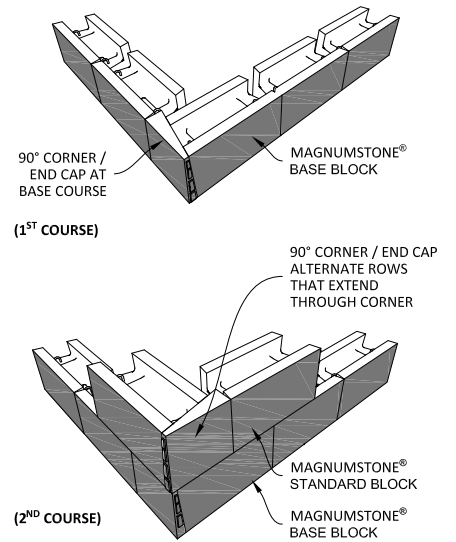
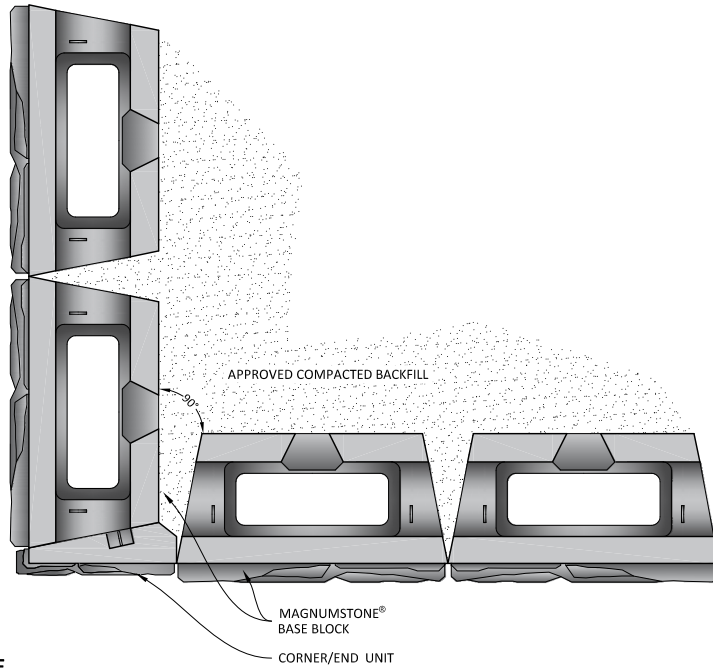



MagnumStone
RETAINING WALLS

www.magnumstone.com | 1 (800) 939-9193

MAGNUMSTONE OUTSIDE CORNER (ODD-ANGLED) WALL GENERIC LAYOUT

SHEET CONTENT

104

0102-MS-APX

SHEET REFERENCE

GENERAL NOTES:

These drawings are intended solely to act as an aid when designing a wall. This drawing should not be used for final design or construction.

Each site-specific wall should be certified and signed by a registered geotechnical engineer in the State or Province that it is being built. The accuracy and use of the details in this document are the sole responsibility of the user.

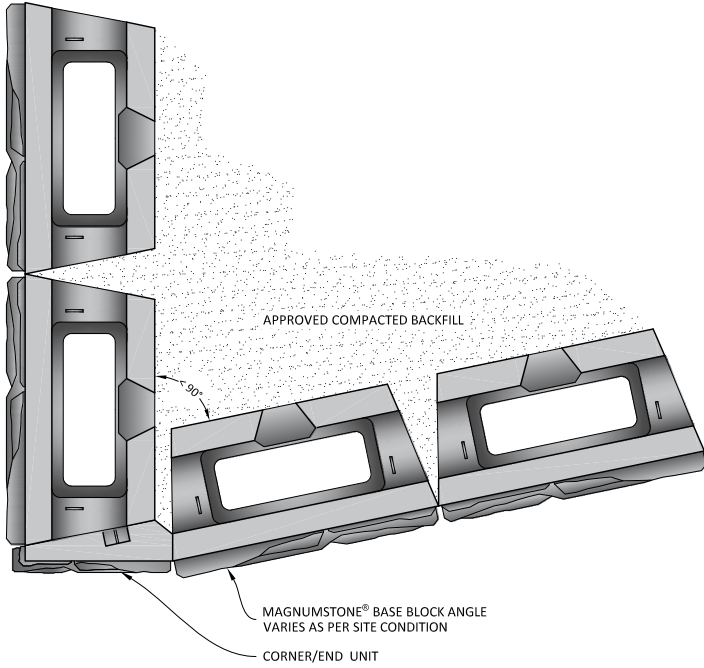

1ST COURSE

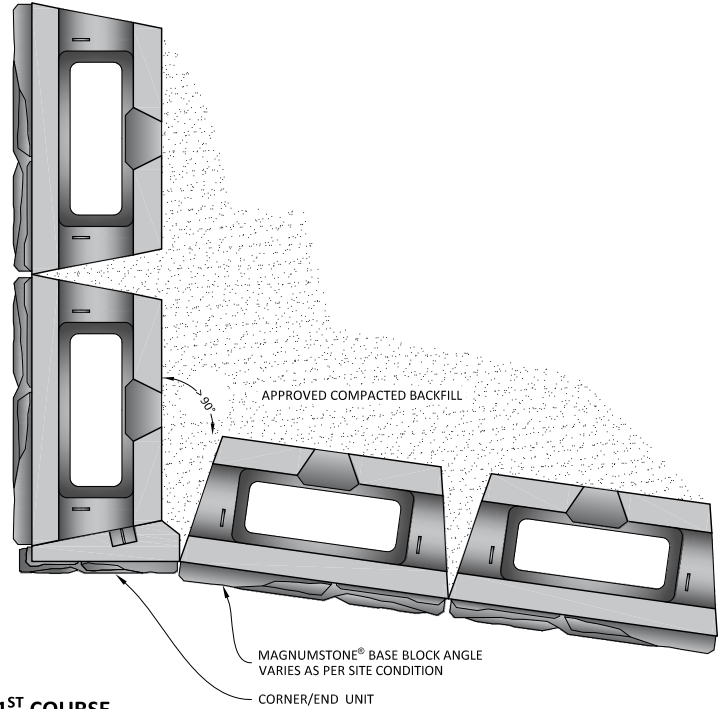

1ST COURSE

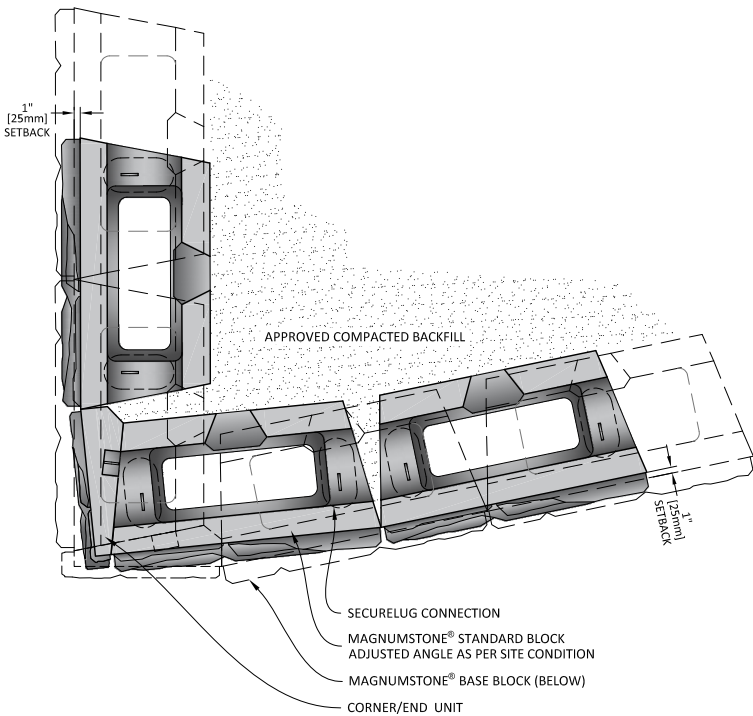

2ND COURSE

ACUTE- ANGLED CORNER

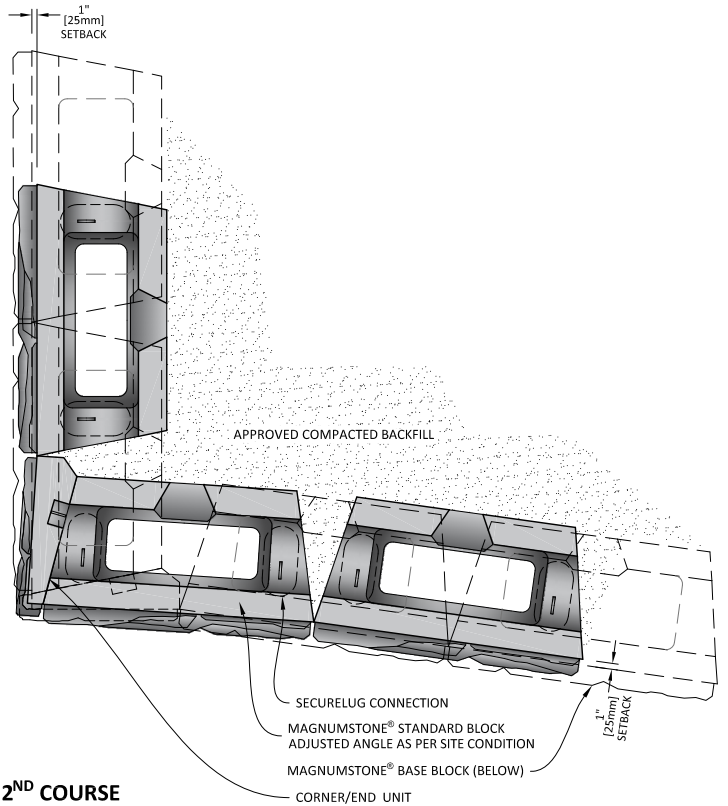

2ND COURSE

OBTUSE- ANGLED CORNER



MagnumStone
RETAINING WALLS

www.magnumstone.com | 1 (800) 939-9193

MAGNUMSTONE GEOGRID CORNER WALL DIAGRAM

SHEET CONTENT

201

0102-MS-APX

SHEET REFERENCE

GENERAL NOTES:

These drawings are intended solely to act as an aid when designing a wall. This drawing should not be used for final design or construction.

Each site-specific wall should be certified and signed by a registered geotechnical engineer in the State or Province that it is being built. The accuracy and use of the details in this document are the sole responsibility of the user.

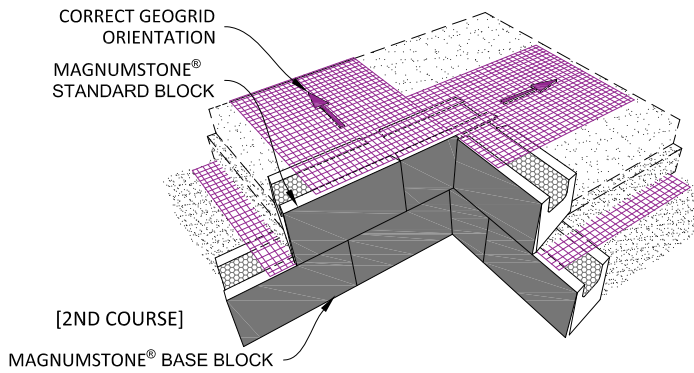
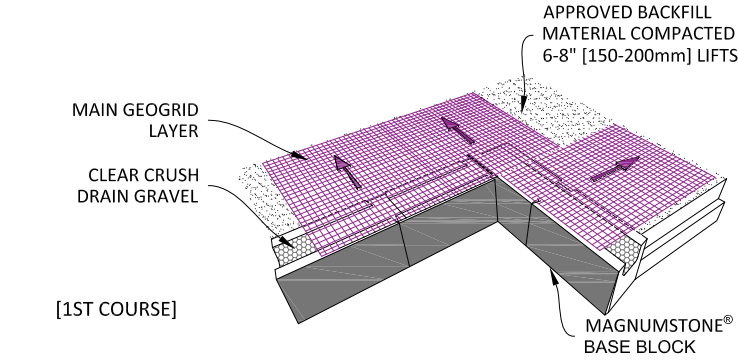

INSIDE CORNER

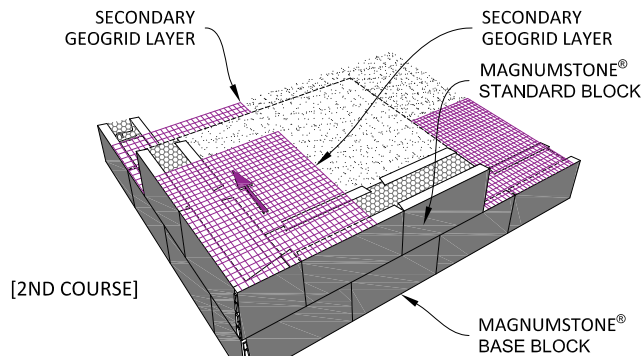
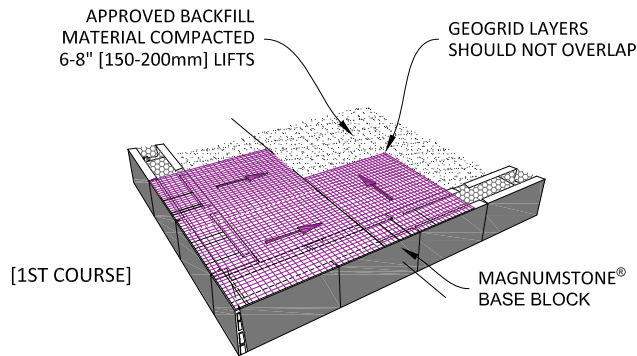

OUTSIDE CORNER



MagnumStone
RETAINING WALLS

www.magnumstone.com | 1 (800) 939-9193

MAGNUMSTONE GRAVITY CORNER WALL DIAGRAM

SHEET CONTENT

202

0102-MS-APX

SHEET REFERENCE

GENERAL NOTES:

These drawings are intended solely to act as an aid when designing a wall. This drawing should not be used for final design or construction. Each site-specific wall should be certified and signed by a registered geotechnical engineer in the State or Province that it is being built. The accuracy and use of the details in this document are the sole responsibility of the user.

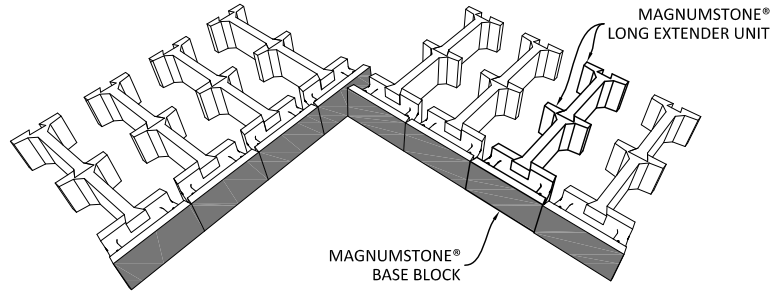

[1ST COURSE]

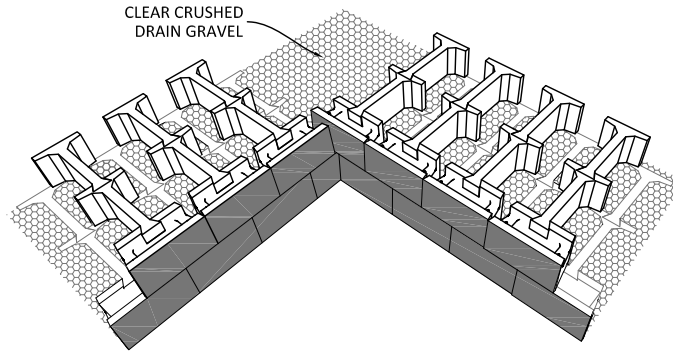

[2ND COURSE]

INSIDE CORNER

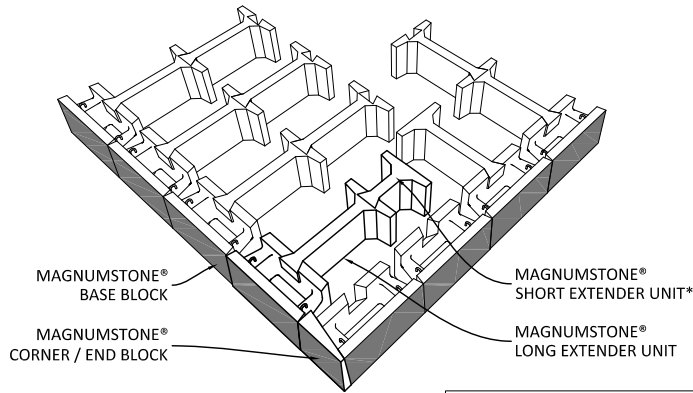

[1ST COURSE]

(* NOTE:
LAYOUT OF EXTENDERS ADJUSTED TO FIT
TIGHT CURVES WHERE SPACE ALLOWS

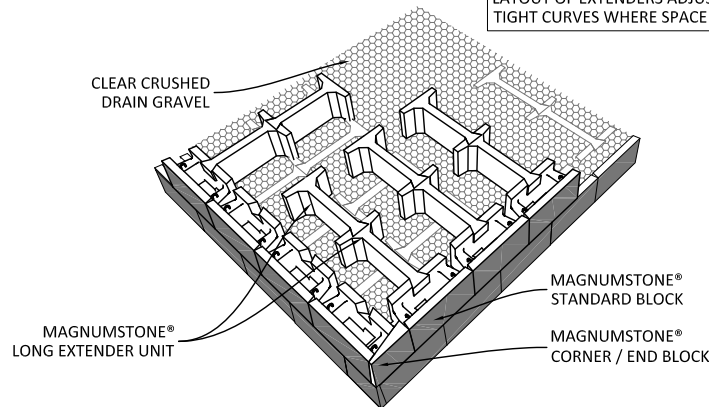

[2ND COURSE]

OUTSIDE CORNER



MagnumStone
RETAINING WALLS

www.magnumstone.com | 1 (800) 939-9193

MAGNUMSTONE POSITIVE CONNECTION CORNER WALL DIAGRAM

SHEET CONTENT

203

0102-MS-APX

SHEET REFERENCE

GENERAL NOTES:

These drawings are intended solely to act as an aid when designing a wall. This drawing should not be used for final design or construction. Each site-specific wall should be certified and signed by a registered geotechnical engineer in the State or Province that it is being built. The accuracy and use of the details in this document are the sole responsibility of the user.

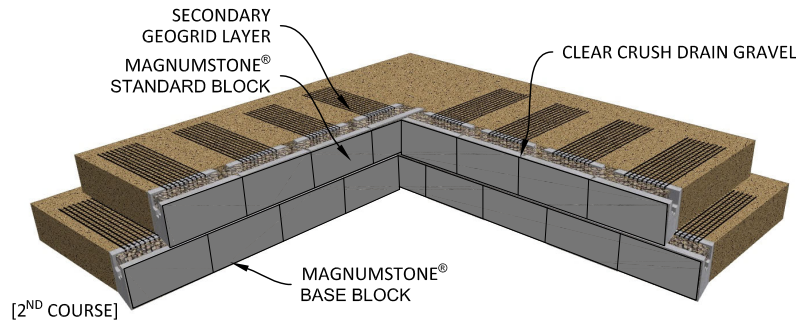
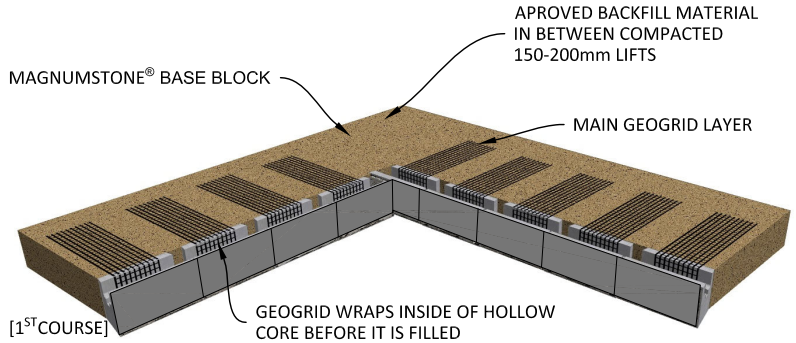

INSIDE CORNER

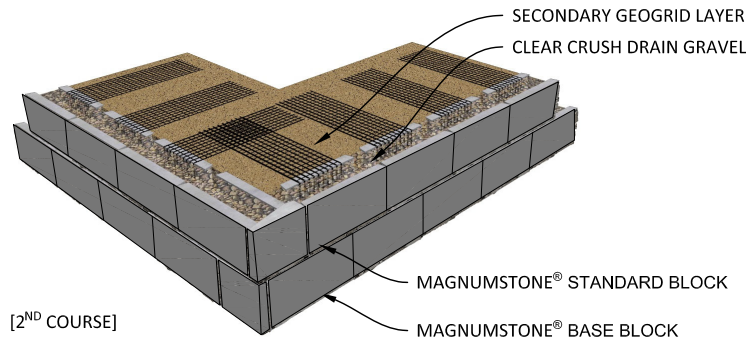
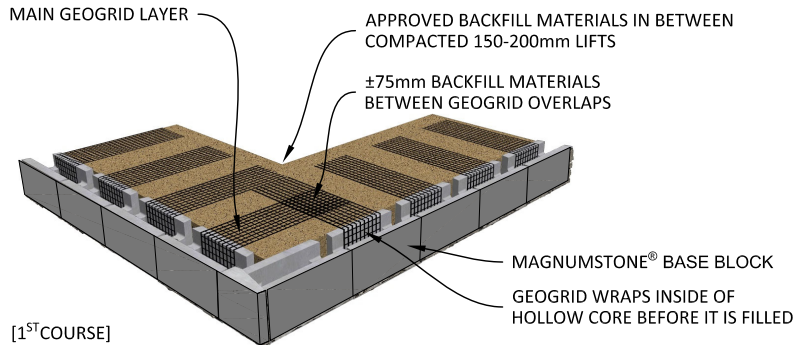

OUTSIDE CORNER