

01 WALL CROSS SECTION
SCALE 1:25

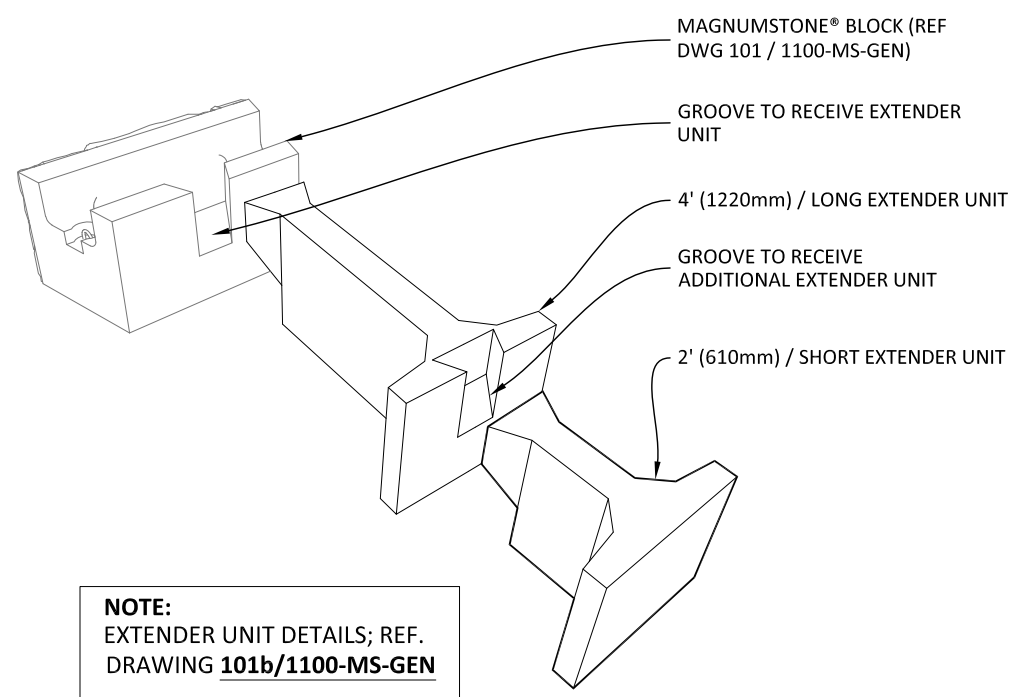

NOTE:
EXTENDER UNIT DETAILS; REF.
DRAWING **101b/1100-MS-GEN**

02 ISOMETRIC VIEW

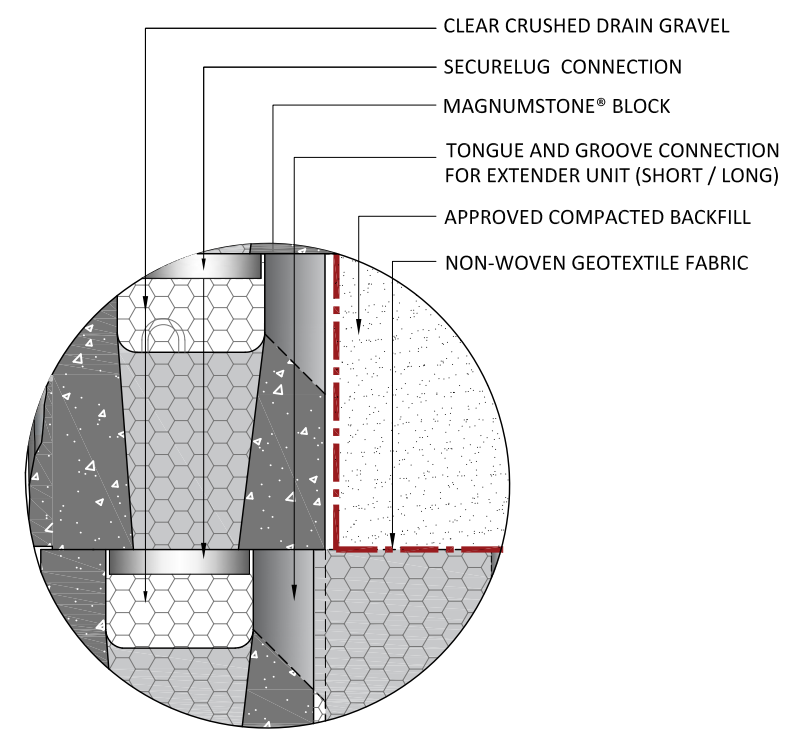

03 DETAIL
N.T.S.

GENERAL NOTES:
These drawings are intended solely to act as an aid when designing a wall. This drawing should not be used for final design or construction.
Each site-specific wall should be certified and signed by a registered geotechnical engineer in the State or Province that it is being built.
The accuracy and use of the details in this document are the sole responsibility of the user.

Rev	DESCRIPTION	DATE
01	ADDENDUM INFORMATION	08-10-2023
00	INTERNAL APPROVAL	07-01-2023

REMARKS:

PURPOSE OF ISSUE:
 INFORMATION
 REVIEW / APPROVAL
 PRODUCTION

SHEET CONTENT
MAGNUMSTONE® GRAVITY WALL CROSS SECTION DETAILS

SHEET REFERENCE

101

1102-MS-GVT

DRAWING INFORMATION
 SCALE: AS INDICATED
 PAPER SIZE: 17" WD X 11" HT
 PREPARED BY: RM



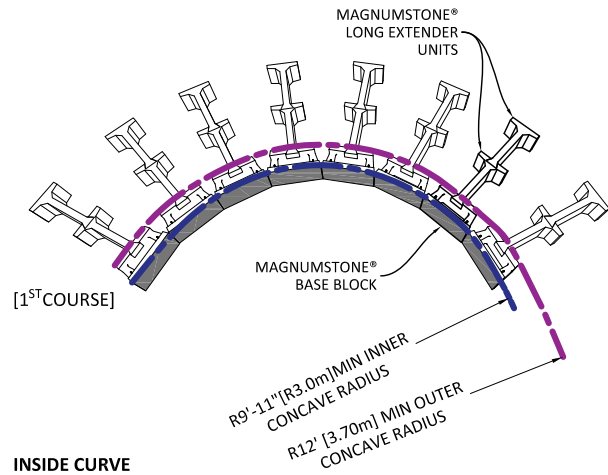
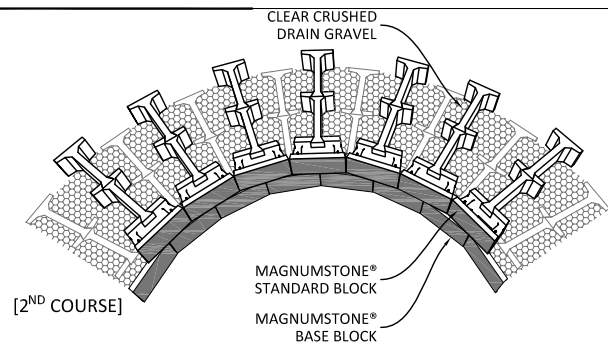

INSIDE CURVE

01

CURVES AND CORNERS

N.T.S.

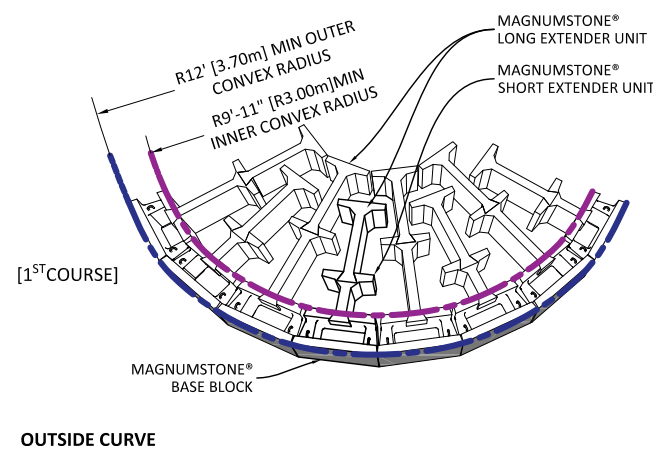
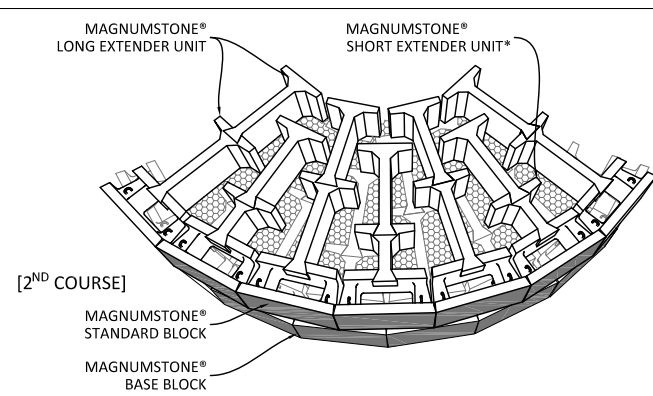

OUTSIDE CURVE

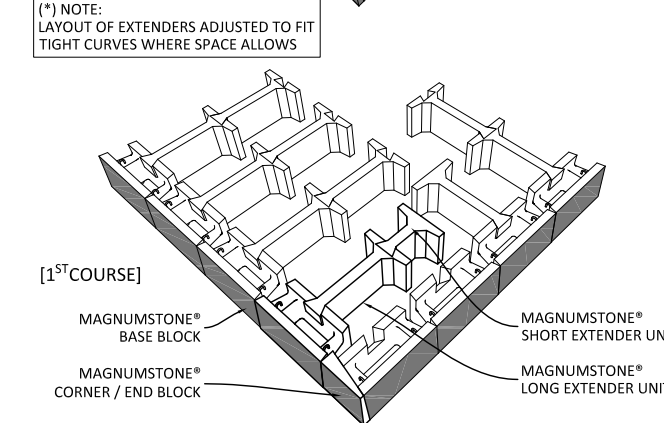
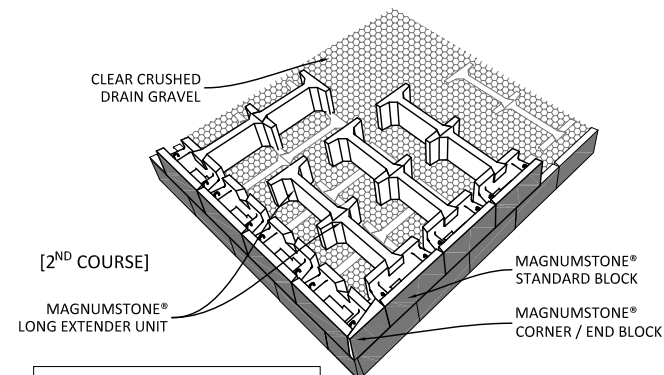

OUTSIDE CORNER

(* NOTE: LAYOUT OF EXTENDERS ADJUSTED TO FIT TIGHT CURVES WHERE SPACE ALLOWS

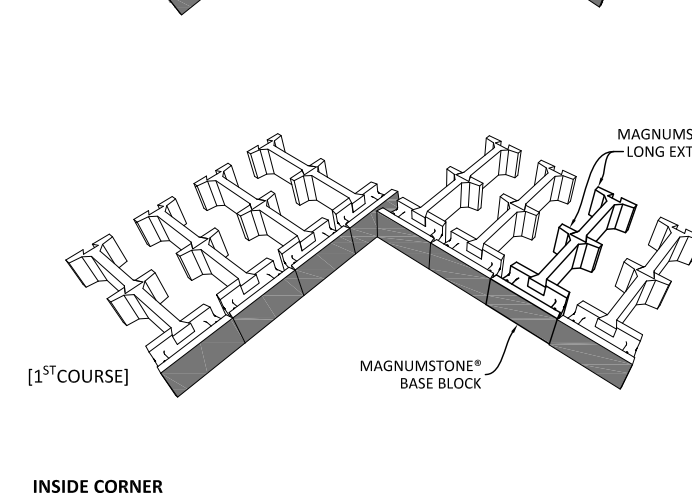
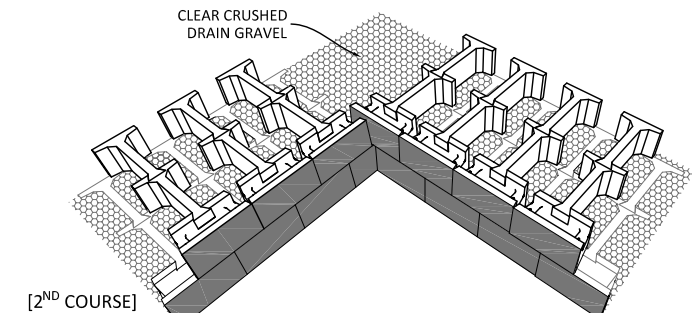

INSIDE CORNER

GENERAL NOTES:

These drawings are intended solely to act as an aid when designing a wall. This drawing should not be used for final design or construction.

Each site-specific wall should be certified and signed by a registered geotechnical engineer in the State or Province that it is being built.

The accuracy and use of the details in this document are the sole responsibility of the user.

Rev	DESCRIPTION	DATE
01	ADDENDUM INFORMATION	08-10-2023
00	INTERNAL APPROVAL	07-01-2023

REMARKS:

- PURPOSE OF ISSUE:**
- INFORMATION
 - REVIEW / APPROVAL
 - PRODUCTION

SHEET CONTENT
MAGNUMSTONE®
GRAVITY WALL
COMMON APPLICATION

SHEET REFERENCE

102

1102-MS-GVT

DRAWING INFORMATION

SCALE: AS INDICATED
 PAPER SIZE: 17" WD X 11" HT
 PREPARED BY: RM

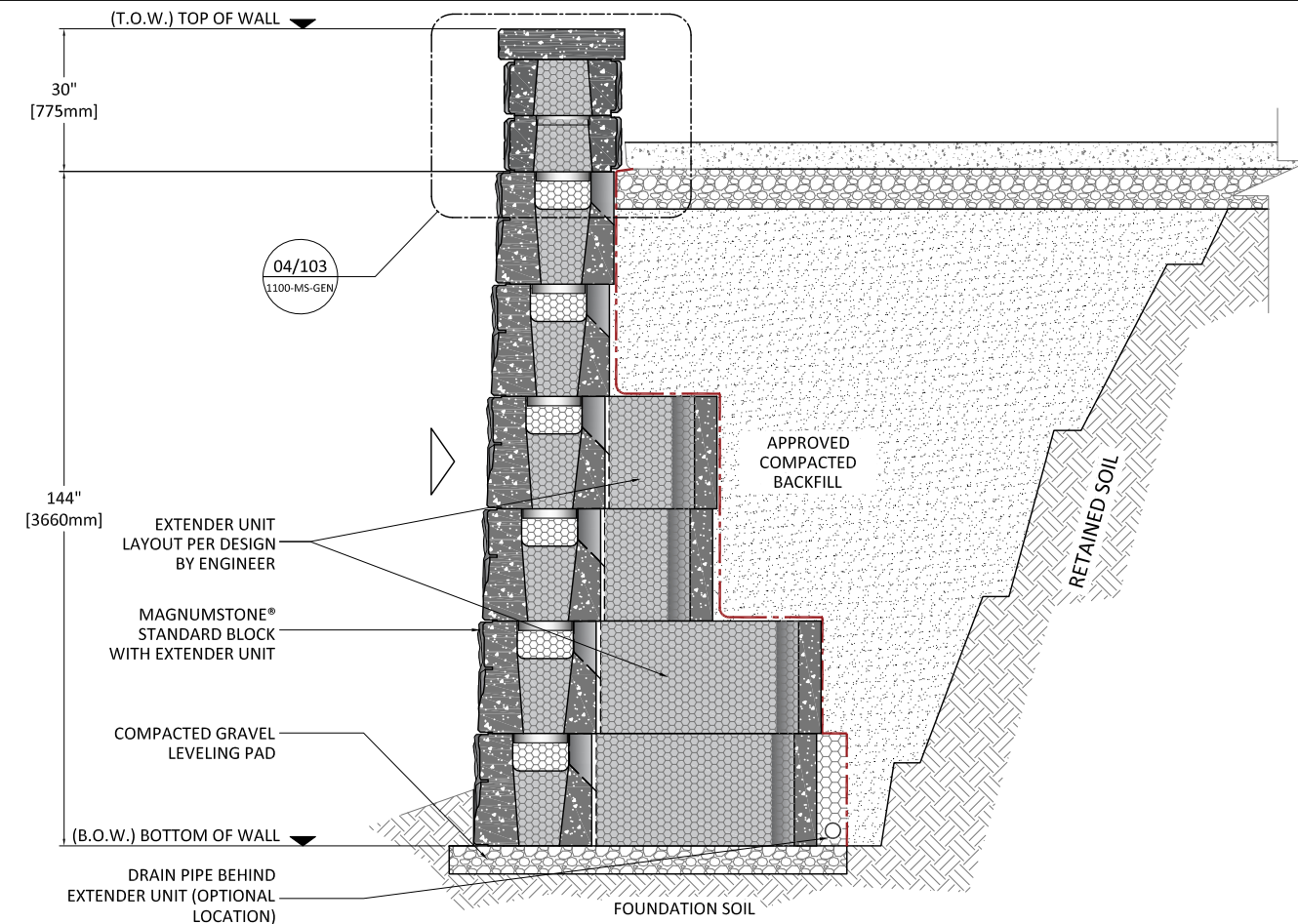

02

FREESTANDING SEATING WALL ON GRAVITY WALL

SCALE 1:40

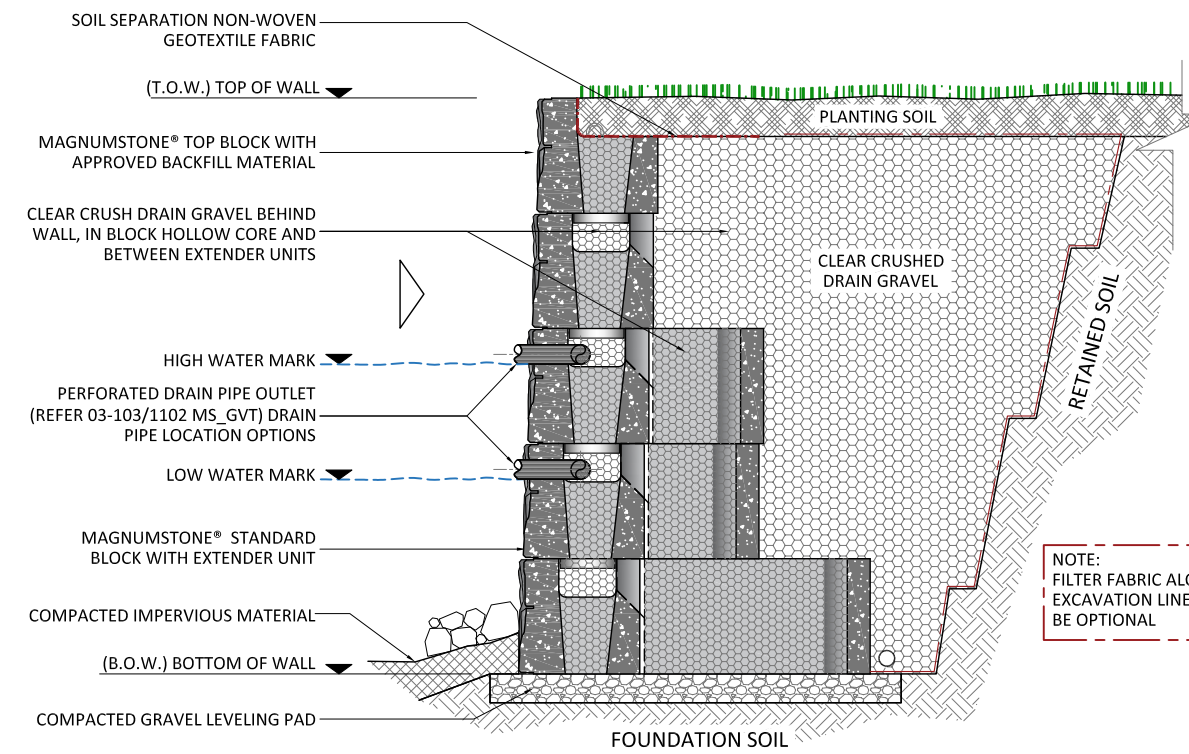

03

WATER APPLICATION OF GRAVITY WALL

SCALE 1:40

EXTENDER UNIT - GENERAL NOTE:

- EXTENDER UNITS TO BE ATTACHED ONTO MAGNUMSTONE® STANDARD, BASE BLOCK OR ANOTHER EXTENDER UNIT TO CREATE DEEPER BLOCKS AND ADD MASS FROM THE STANDARD MAGNUMSTONE® BLOCK
- EXTENDER UNITS USE A TONGUE-AND-GROOVE CONNECTION TO LOCK INTO THE BACK OF A PROVIDED GROOVE OF THE STANDARD MAGNUMSTONE® BLOCK OR LONG EXTENDER UNIT
- EXTENDER UNITS ARE CHAINED TOGETHER IN 2' [610 mm] INCREMENTS. THE NUMBER OF EXTENDERS MAY BE DETERMINED BY THE ENGINEER ON RECORD THROUGH THE DESIGN ANALYSIS SOFTWARE.

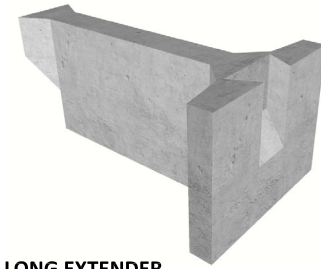

LONG EXTENDER



SHORT EXTENDER

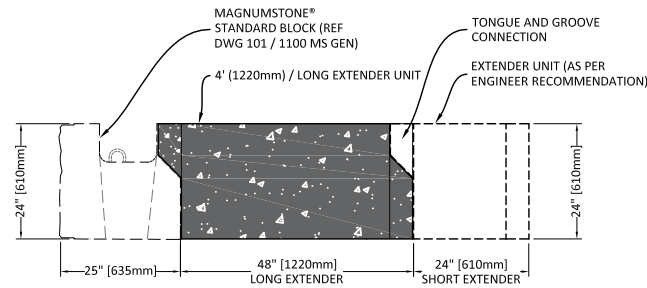

TYPICAL CROSS SECTION

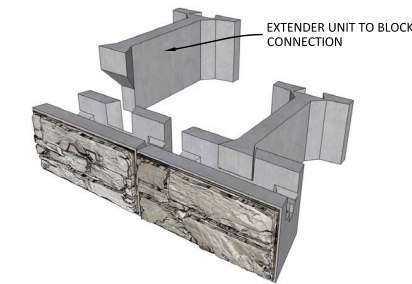

**ISOMETRIC VIEW
BLOCK-TO-EXTENDER UNIT**

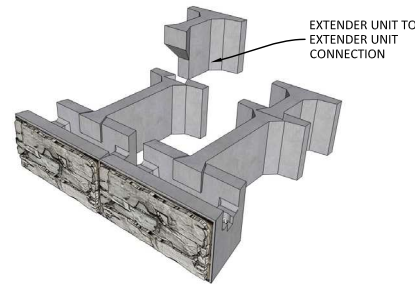

**ISOMETRIC VIEW
EXTENDER-TO-EXTENDER UNIT**

NOTE:
EXTENDER UNIT DETAILS; REFER
DRAWING **101b/1100-MS-GEN**

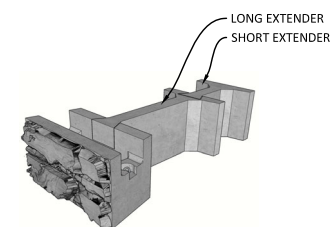
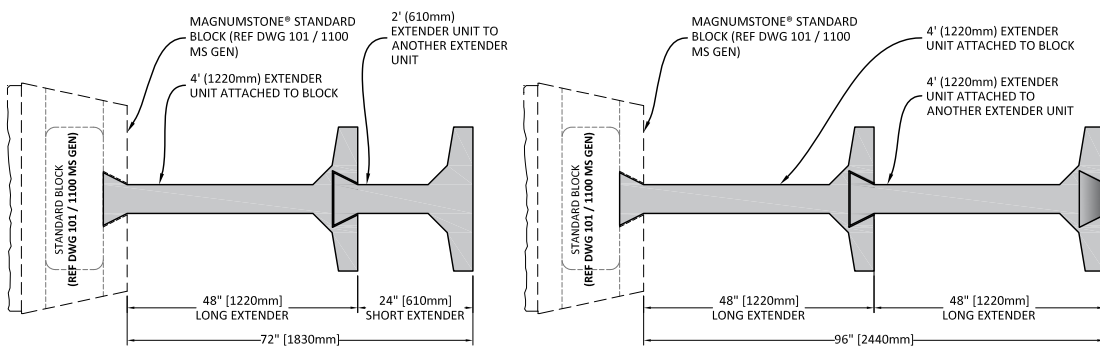

EXTENDER OPTION 01

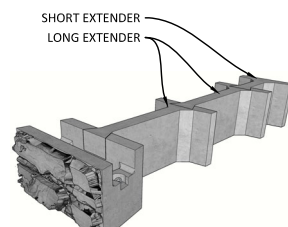

EXTENDER OPTION 02

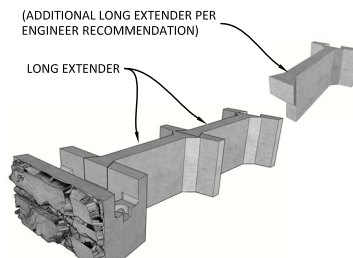

EXTENDER OPTION 03

01 EXTENDER UNIT CONFIGURATION
N.T.S.

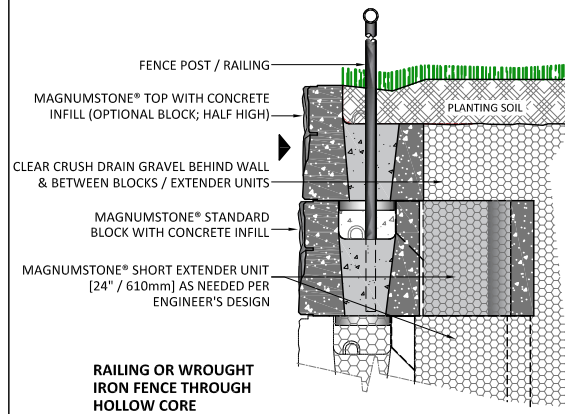

**RAILING OR WROUGHT
IRON FENCE THROUGH
HOLLOW CORE**

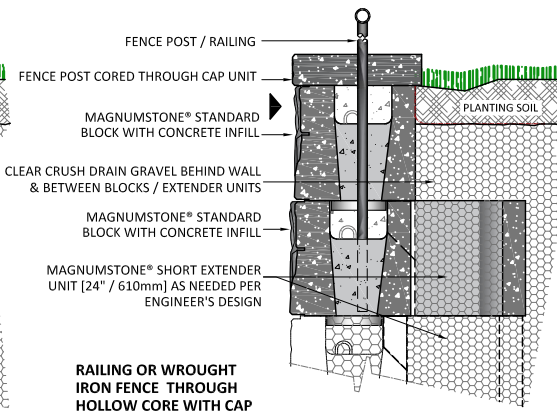

**RAILING OR WROUGHT
IRON FENCE THROUGH
HOLLOW CORE WITH CAP**

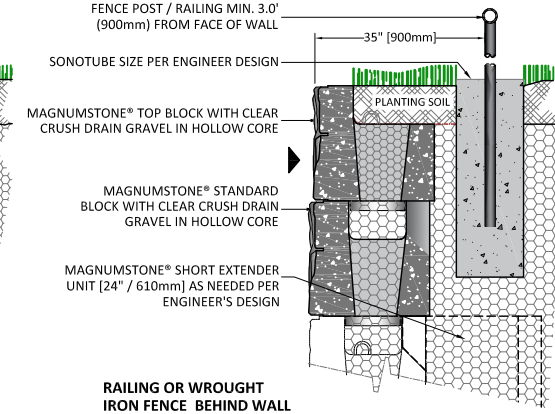

**RAILING OR WROUGHT
IRON FENCE BEHIND WALL**

02a FENCE OPTIONS
SCALE 1:50

FENCE GENERAL NOTE:
1. FENCE POST / RAILING DESIGN BY OTHERS
2. DESIGN TO BE PERFORMED BY ENGINEER

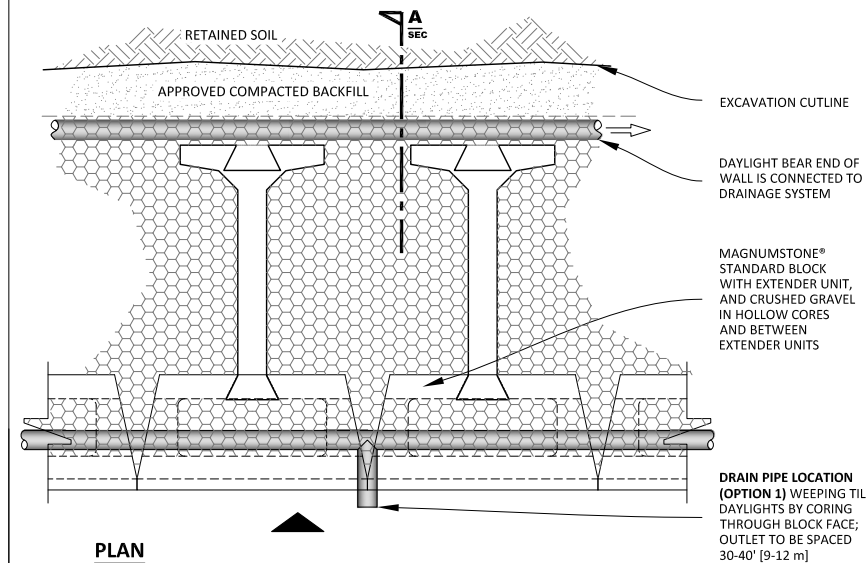

PLAN

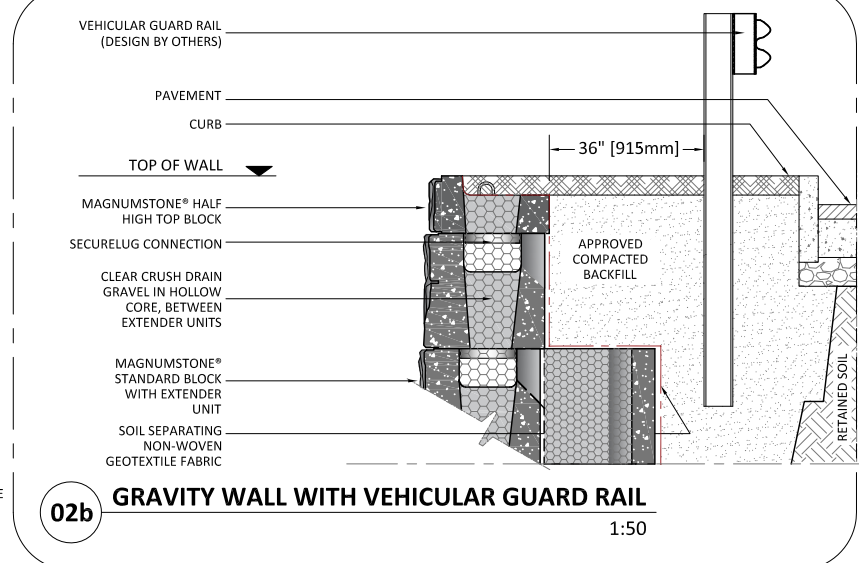

02b GRAVITY WALL WITH VEHICULAR GUARD RAIL
1:50

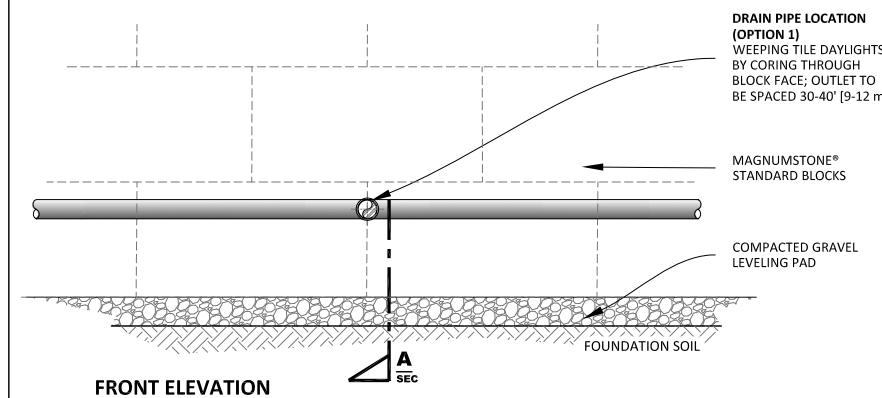

FRONT ELEVATION

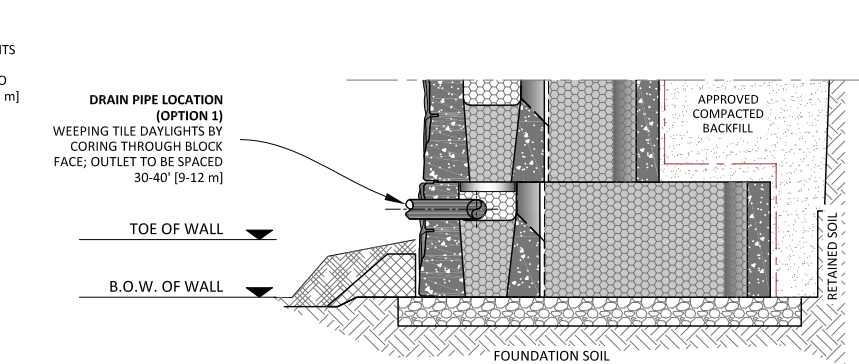

OPTION 01

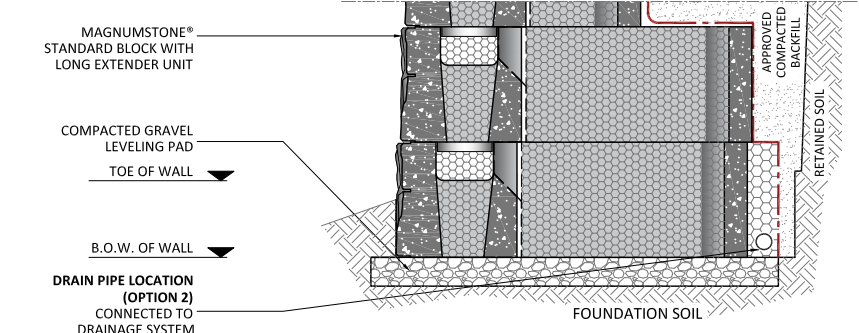

OPTION 02

03 DRAIN PIPE OPTIONAL LOCATION
GRAVITY RETAINING WALL 1:50

DRAIN PIPE - GENERAL NOTE:

- DRAIN PIPE LOCATIONS MENTIONED ABOVE ARE POTENTIAL DESIGN OPTIONS. OTHER OPTIONS ARE AVAILABLE AS PER ENGINEER'S DISCRETION
- WEEPING TILE DAYLIGHTS BY CORING THROUGH BLOCK FACE; OUTLET TO BE SPACED 30-40' [9-12 m]

GENERAL NOTES:

These drawings are intended solely to act as an aid when designing a wall. This drawing should not be used for final design or construction.

Each site-specific wall should be certified and signed by a registered geotechnical engineer in the State or Province that it is being built.

The accuracy and use of the details in this document are the sole responsibility of the user.

Rev	DESCRIPTION	DATE
01	ADDENDUM INFORMATION	08-10-2023
00	INTERNAL APPROVAL	07-01-2023

REMARKS:

- PURPOSE OF ISSUE:**
- INFORMATION
 - REVIEW / APPROVAL
 - PRODUCTION

SHEET CONTENT
**MAGNUMSTONE®
GRAVITY WALL
ADDENDUM DETAILS**

SHEET REFERENCE

103

1102-MS-GVT

DRAWING INFORMATION
SCALE: AS INDICATED
PAPER SIZE: 17" WD X 11" HT
PREPARED BY: RM



**MagnumStone®
RETAINING WALLS**
www.MAGNUMSTONE.com | 1.800.938-9193

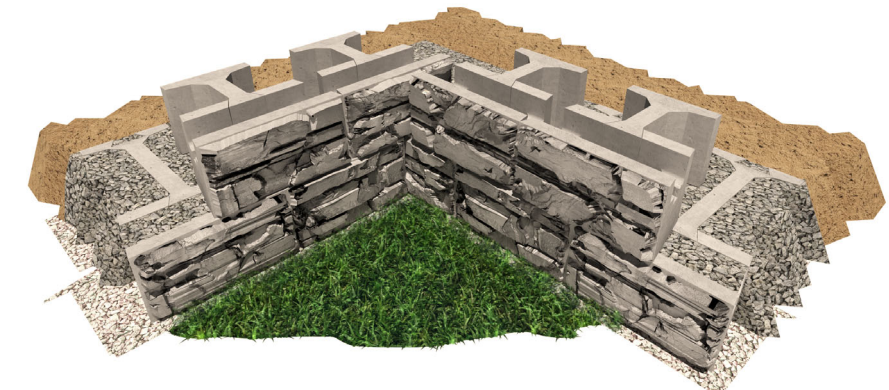
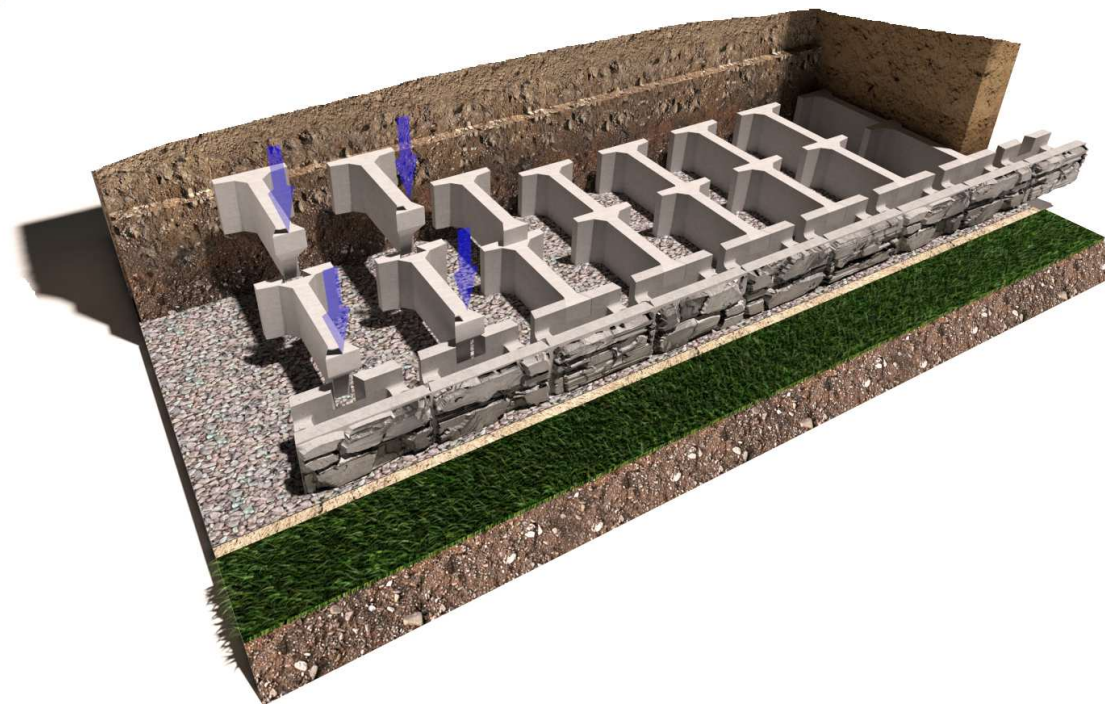
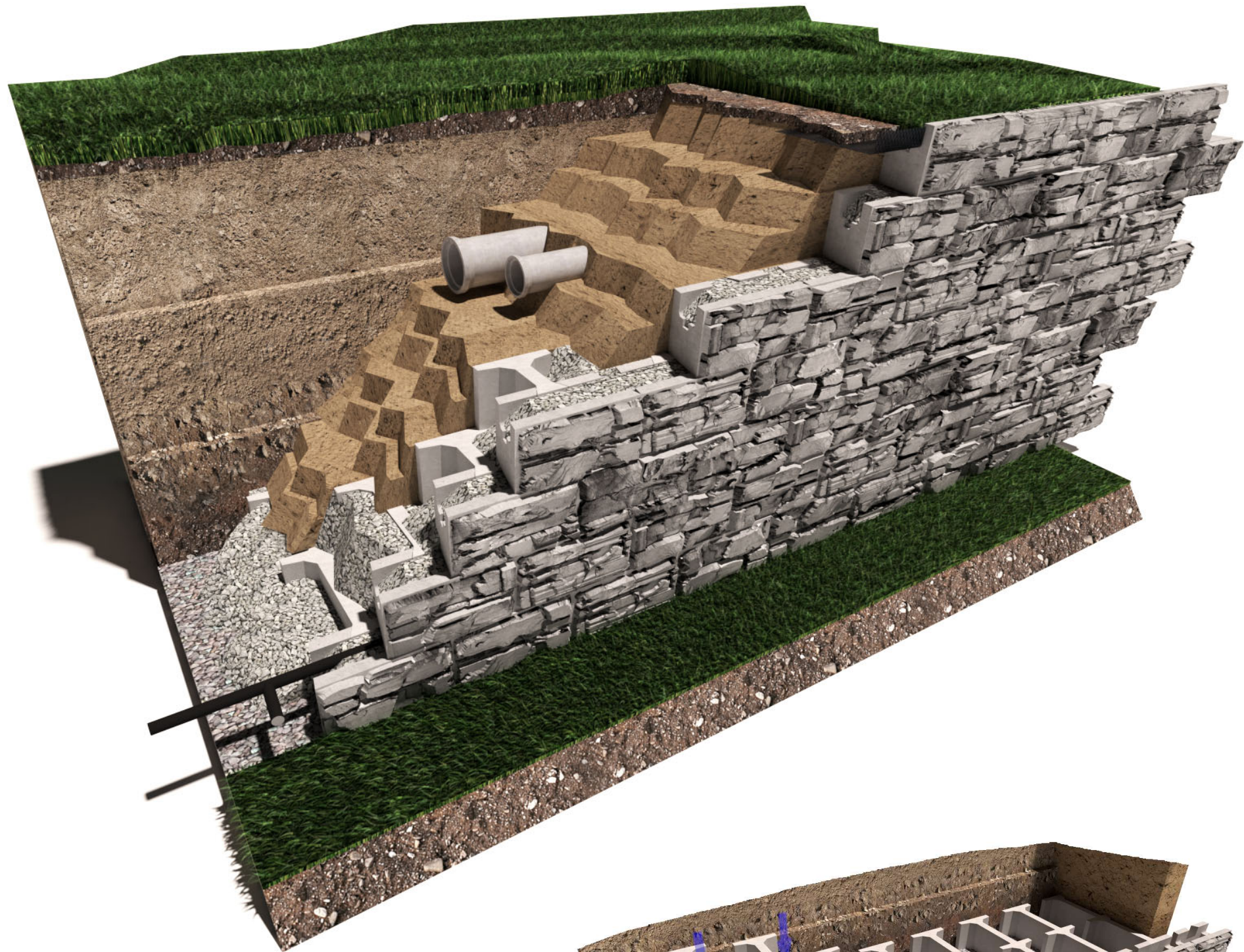

GENERAL NOTES:

These drawings are intended solely to act as an aid when designing a wall. This drawing should not be used for final design or construction.

Each site-specific wall should be certified and signed by a registered geotechnical engineer in the State or Province that it is being built.

The accuracy and use of the details in this document are the sole responsibility of the user.

Rev	DESCRIPTION	DATE
01	ADDENDUM INFORMATION	08-10-2023
00	INTERNAL APPROVAL	07-01-2023

REMARKS:

- PURPOSE OF ISSUE:**
- INFORMATION
 - REVIEW / APPROVAL
 - PRODUCTION

SHEET CONTENT
MAGNUMSTONE®
GRAVITY WALL
PERSPECTIVE

SHEET REFERENCE

201

1102-MS-GVT

DRAWING INFORMATION
 SCALE: AS INDICATED
 PAPER SIZE: 17" WD X 11" HT
 PREPARED BY: RM

