

GENERAL NOTES:

These drawings are intended solely to act as an aid when designing a wall. This drawing should not be used for final design or construction.

Each site-specific wall should be certified and signed by a registered geotechnical engineer in the State or Province that it is being built.

The accuracy and use of the details in this document are the sole responsibility of the user.

01	ADDENDUM INFORMATION	08-10-2023
00	INTERNAL APPROVAL	07-01-2023

Rev	DESCRIPTION	DATE

REMARKS:

PURPOSE OF ISSUE:

- INFORMATION
- REVIEW / APPROVAL
- PRODUCTION

SHEET CONTENT

MAGNUMSTONE® BLOCK GENERAL INFORMATION

PART 1

SHEET REFERENCE

101a

1100-MS-GEN

DRAWING INFORMATION

SCALE: AS INDICATED
 PAPER SIZE: 17" WD X 11" HT
 PREPARED BY: RM



2-SIDED FREESTANDING BLOCK

DESCRIPTION	IMPERIAL	METRIC
Face Width	48"	1220 mm
Back Width	48"	1220 mm
Depth (±)	26"	660 mm
Height	12"	305 mm
Face Area	4 ft ²	0.37 m ²
Weight (±)	900 lbs	408 kg
Setback	0°	

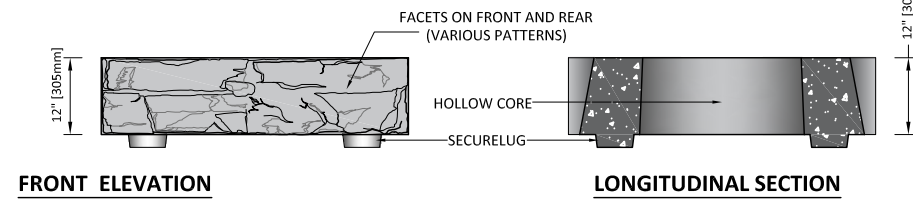
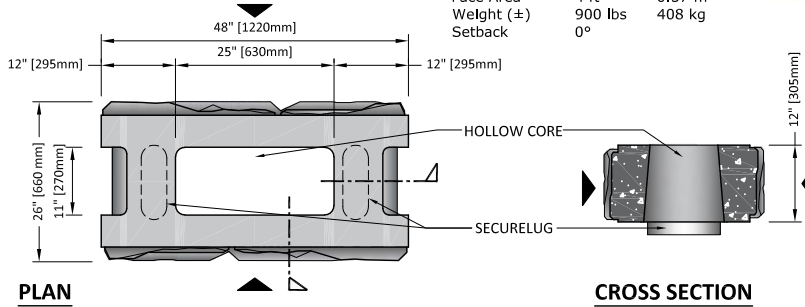

3-SIDED FREESTANDING BLOCK

DESCRIPTION	IMPERIAL	METRIC
Face Width	48"	1220 mm
Back Width	48"	1220 mm
Depth (±)	26"	660 mm
Height	12"	305 mm
Face Area	4 ft ²	0.37 m ²
Weight (±)	900 lbs	408 kg
Setback	0°	

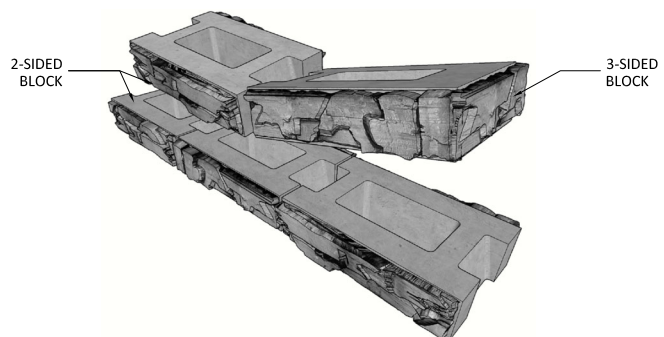
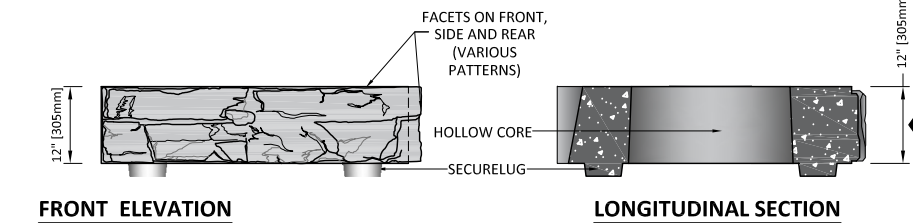
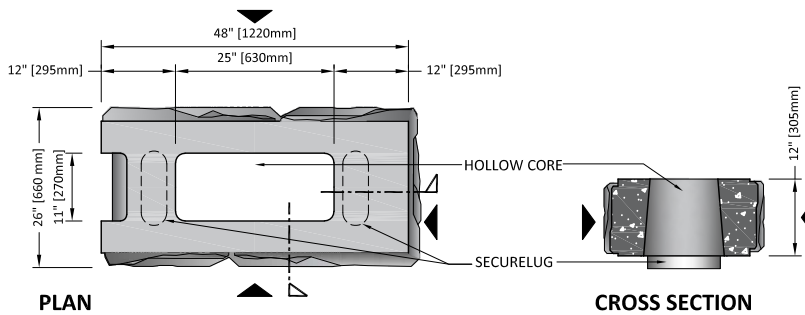

HALF-HIGH CORNER / END UNIT

DESCRIPTION	IMPERIAL	METRIC
Top Face Width(±)	28"	710 mm
Top Narrow Face(±)	4"	110 mm
Height	12"	305 mm
Face Area	2.33 ft ²	0.22 m ²
Weight (±)	170 lbs	77 kg

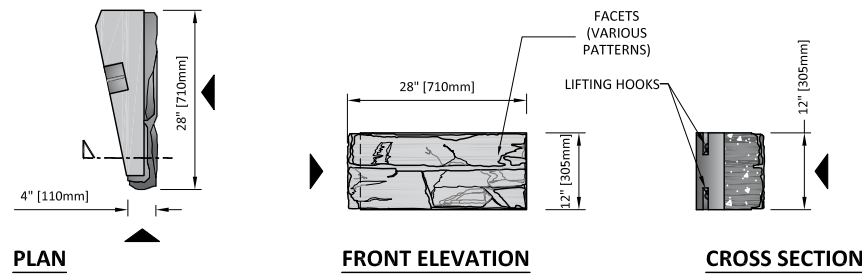

STANDARD CORNER / END UNIT

DESCRIPTION	IMPERIAL	METRIC
Top Face Width(±)	28"	710 mm
Top Narrow Face(±)	4"	110 mm
Height	24"	610 mm
Face Area	4.66 ft ²	0.44 m ²
Weight (±)	340 lbs	154 kg

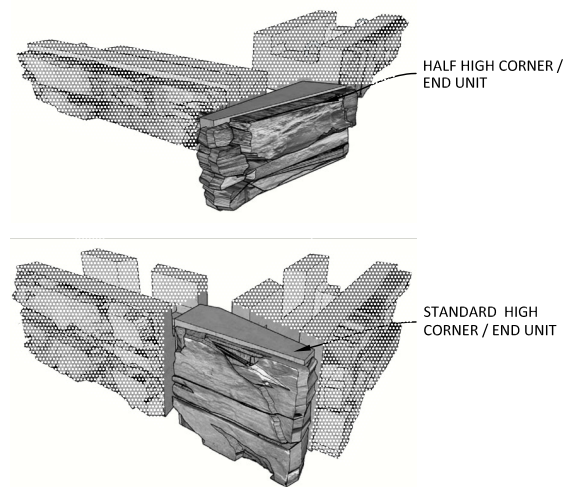
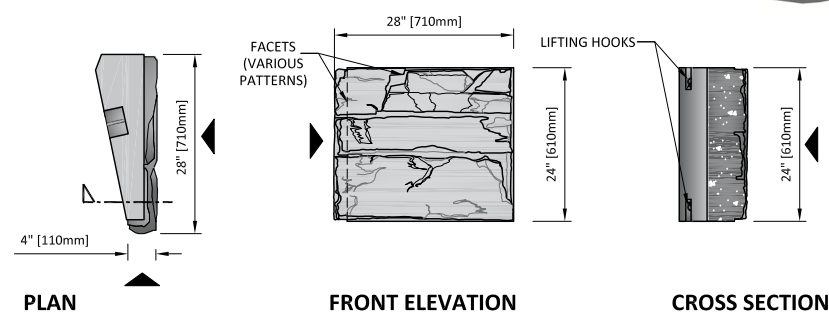

STEP / CAP UNIT

DESCRIPTION	IMPERIAL	METRIC
Face Width	48"	1220 mm
Back Width	48"	1220 mm
Depth (±)	26"	660 mm
Height	6"	165 mm
Face Area	2 ft ²	0.186 m ²
Weight	580 lbs	263 kg

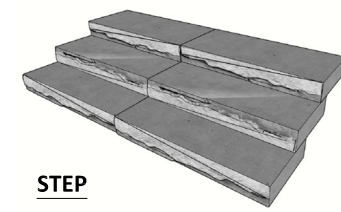
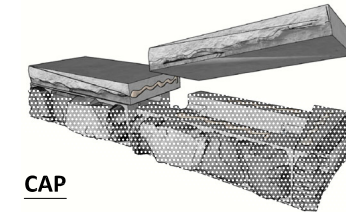
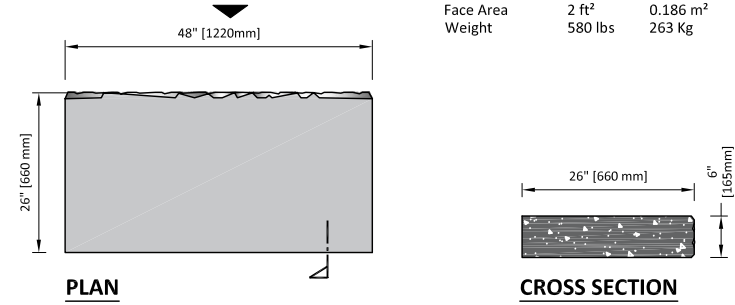

SHORT EXTENDER UNIT

DESCRIPTION	IMPERIAL	METRIC
Extended Length	24"	610 mm
Height	24"	610 mm
Width	30"	765 mm
Weight	520 lbs	236 kg

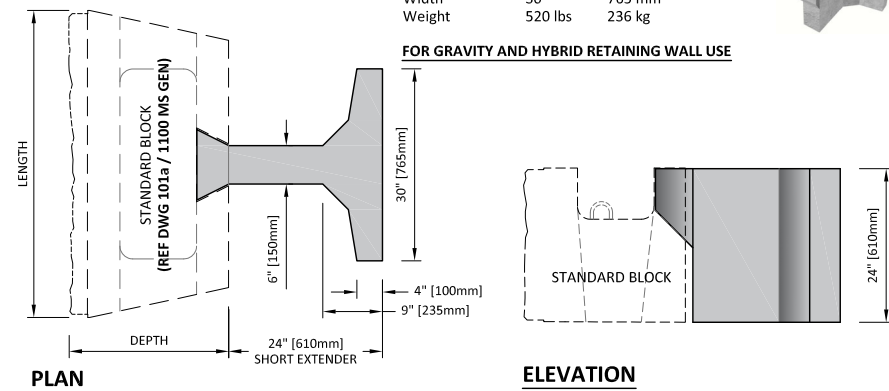
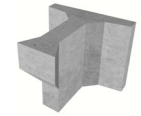

LONG EXTENDER UNIT

DESCRIPTION	IMPERIAL	METRIC
Extended Length	48"	1220 mm
Height	24"	610 mm
Width	30"	765 mm
Weight	820 lbs	372 kg

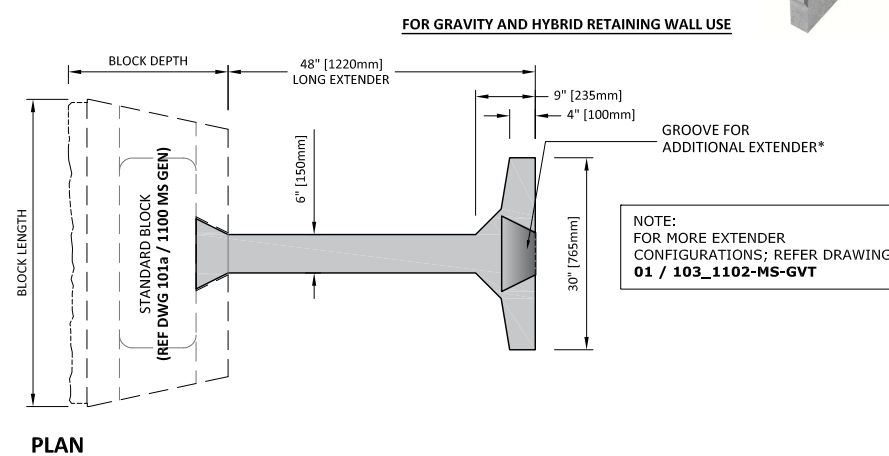
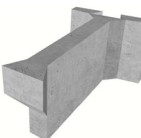

GENERAL NOTES:

These drawings are intended solely to act as an aid when designing a wall. This drawing should not be used for final design or construction.

Each site-specific wall should be certified and signed by a registered geotechnical engineer in the State or Province that it is being built.

The accuracy and use of the details in this document are the sole responsibility of the user.

Rev	DESCRIPTION	DATE
01	ADDENDUM INFORMATION	08-10-2023
00	INTERNAL APPROVAL	07-01-2023

REMARKS:

PURPOSE OF ISSUE:

- INFORMATION
- REVIEW / APPROVAL
- PRODUCTION

SHEET CONTENT

MAGNUMSTONE® BLOCK GENERAL INFORMATION

PART 2

SHEET REFERENCE

101b

1100-MS-GEN

DRAWING INFORMATION

SCALE: AS INDICATED
 PAPER SIZE: 17" WD X 11" HT
 PREPARED BY: RM



CURVE APPLICATION

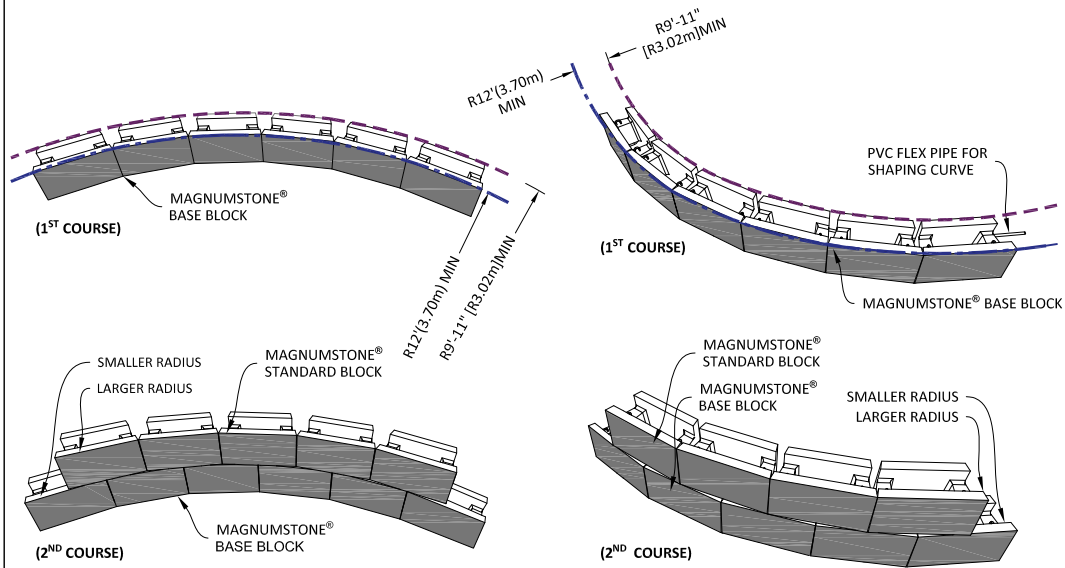

INSIDE CURVE

OUTSIDE CURVE

CORNER APPLICATION

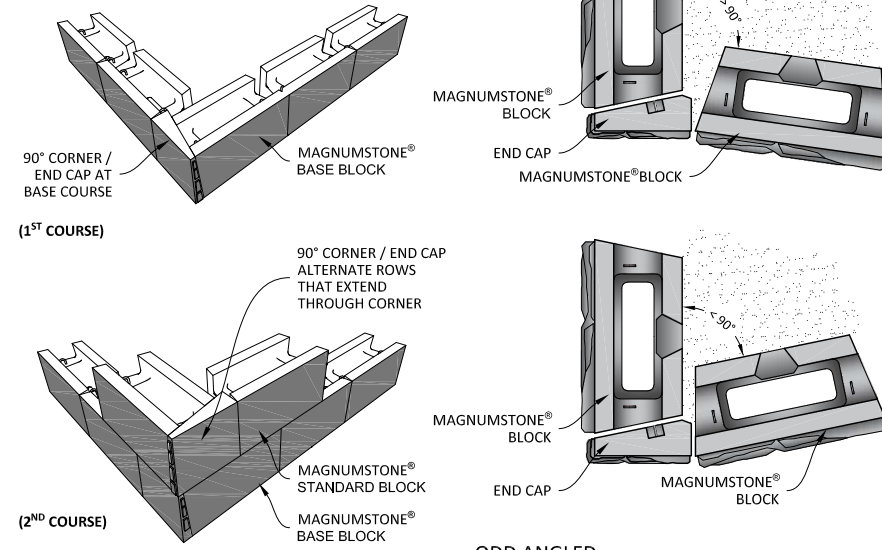

OUTSIDE CORNER

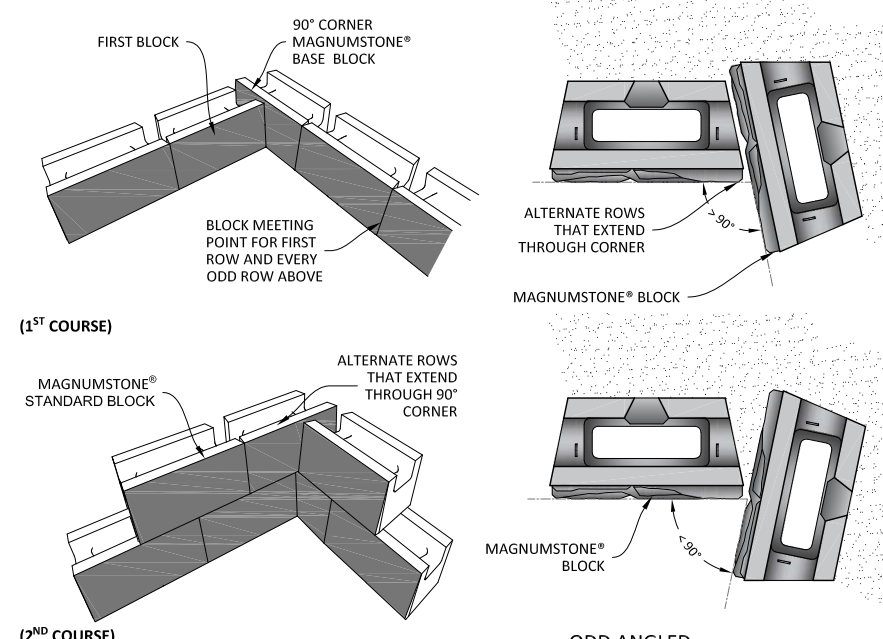

INSIDE CORNER

ODD ANGLED INSIDE CORNER

01 CORNERS AND CURVES
N.T.S.

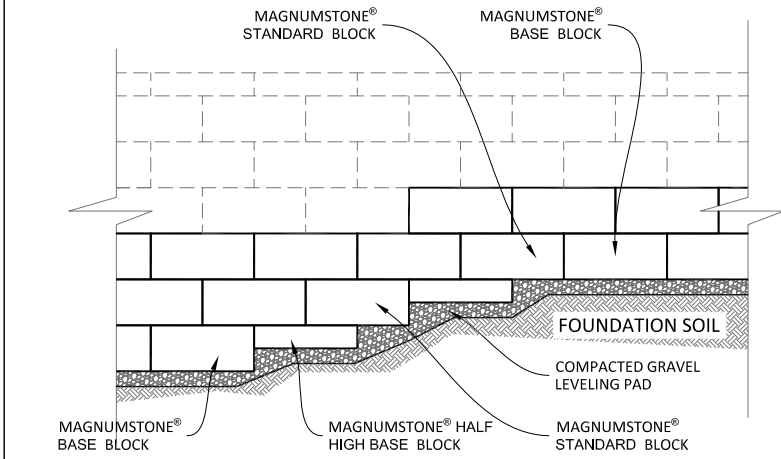

BASE OF WALL STEP UP/ DOWN

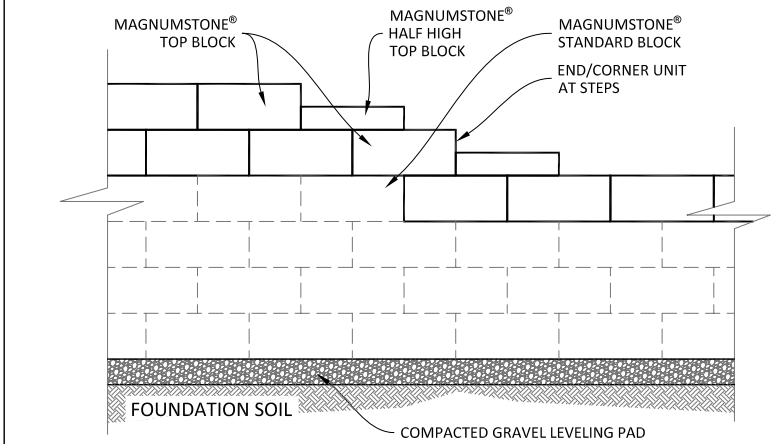

TOP OF WALL STEP UP/ DOWN

02 FRONT ELEVATION
N.T.S.

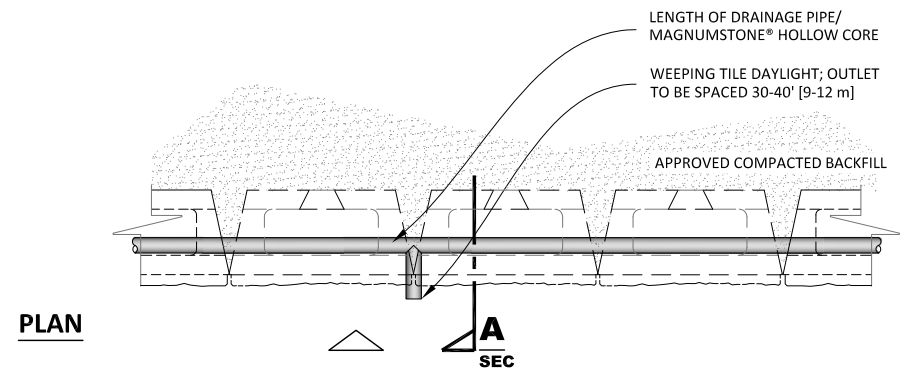

PLAN

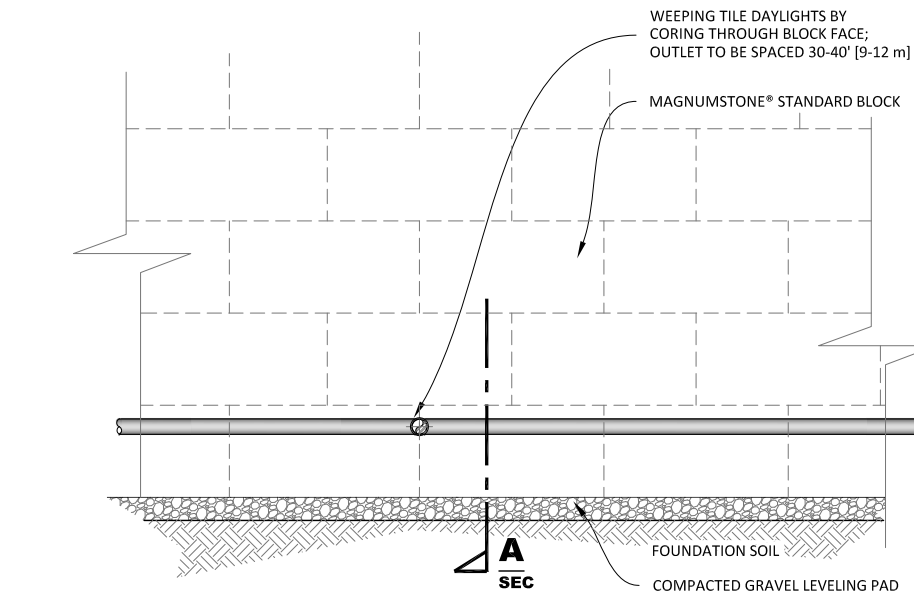

LONGITUDINAL SECTION

03 DRAINAGE PIPE DETAILS
SCALE 1:50

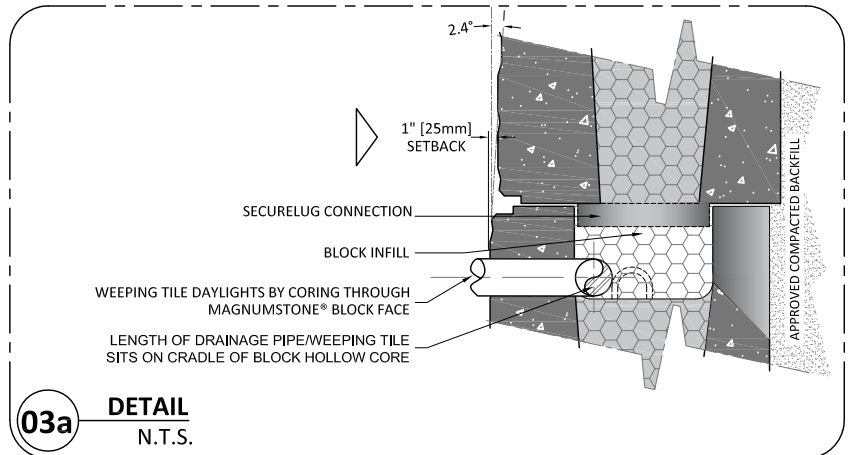

03a DETAIL
N.T.S.

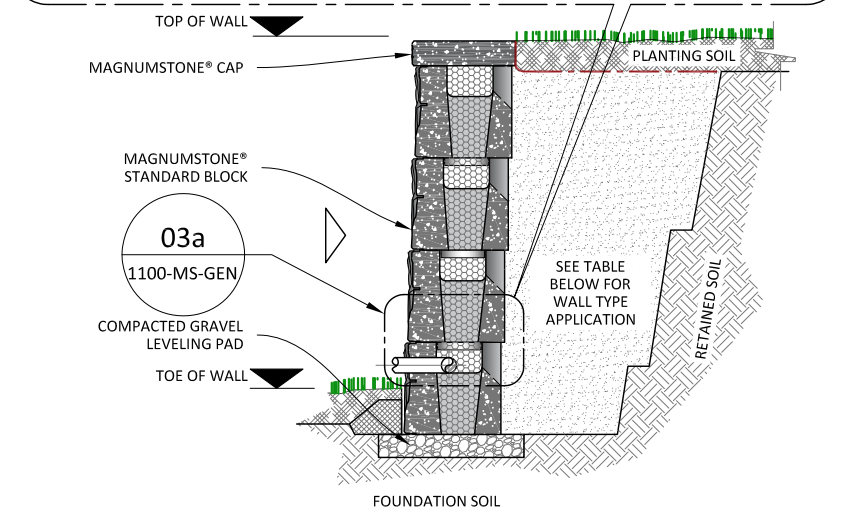

SECTION THROUGH - A

WALL TYPE APPLICATION	
DESCRIPTION	DRAWING REF. NO
GEOGRID RETAINING WALL	1101- MS_GEO
GRAVITY RETAINING WALL	1102- MS_GVT
POSITIVE CONNECTION WALL	1103-MS_PCT
PLANTABLE WALL	1104-MS_PLT
OTHER APPLICATION	1105-MS_UCV

GENERAL NOTES:

These drawings are intended solely to act as an aid when designing a wall. This drawing should not be used for final design or construction.

Each site-specific wall should be certified and signed by a registered geotechnical engineer in the State or Province that it is being built.

The accuracy and use of the details in this document are the sole responsibility of the user.

01 ADDENDUM INFORMATION 08-10-2023

00 INTERNAL APPROVAL 07-01-2023

Rev DESCRIPTION DATE

REMARKS:

- PURPOSE OF ISSUE:**
- INFORMATION
 - REVIEW / APPROVAL
 - PRODUCTION

SHEET CONTENT

MAGNUMSTONE® GENERAL INFORMATION

COMMON APPLICATION: CURVES AND CORNERS DRAIN PIPE LOCATION BASE AND TOP OF WALL

SHEET REFERENCE

102
1100-MS-GEN

DRAWING INFORMATION
SCALE: AS INDICATED
PAPER SIZE: 17" WD X 11" HT
PREPARED BY: RM



STANDARD TOP OF WALL OPTIONS

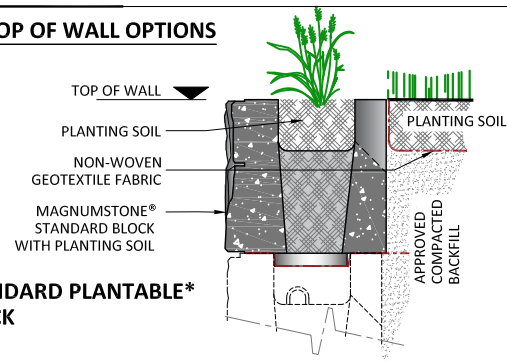

STANDARD PLANTABLE* BLOCK

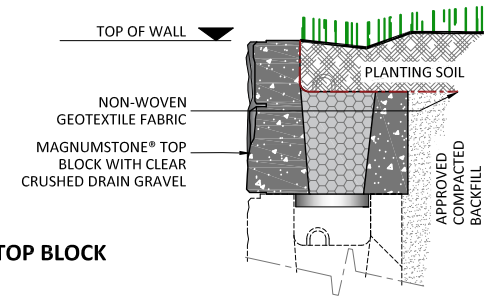

TOP BLOCK

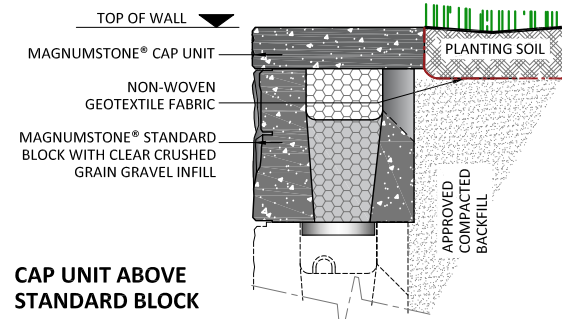

CAP UNIT ABOVE STANDARD BLOCK

FENCE OPTIONS **

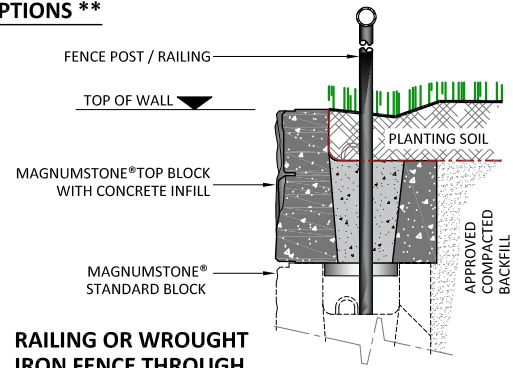

RAILING OR WROUGHT IRON FENCE THROUGH HOLLOW CORE

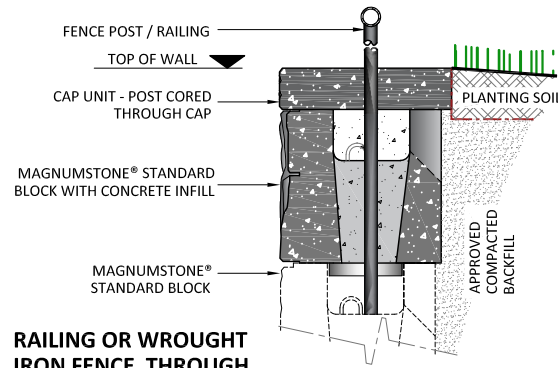

RAILING OR WROUGHT IRON FENCE THROUGH HOLLOW CORE WITH CAP

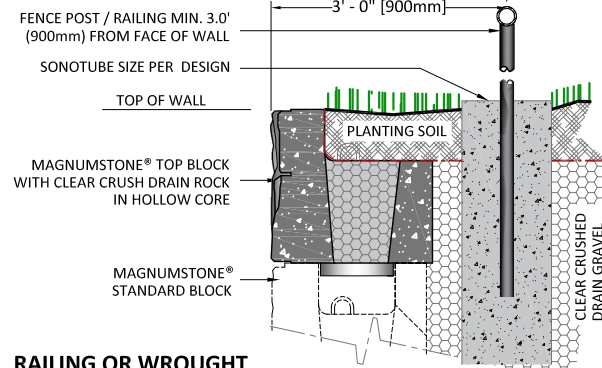

RAILING OR WROUGHT IRON FENCE BEHIND WALL

SWALE OPTIONS

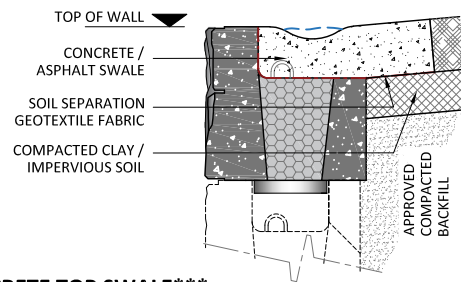

CONCRETE TOP SWALE***

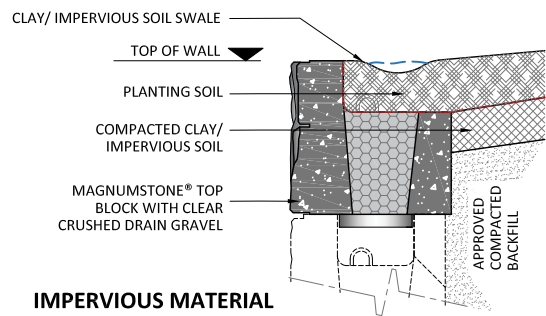

IMPERVIOUS MATERIAL TOP SWALE ***

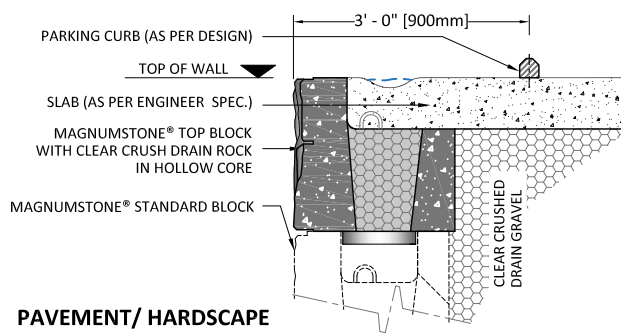

PAVEMENT/ HARDSCAPE

01 TOP OF WALL DETAILS
SCALE 1:25

DRAIN PIPE OPTIONAL LOCATIONS

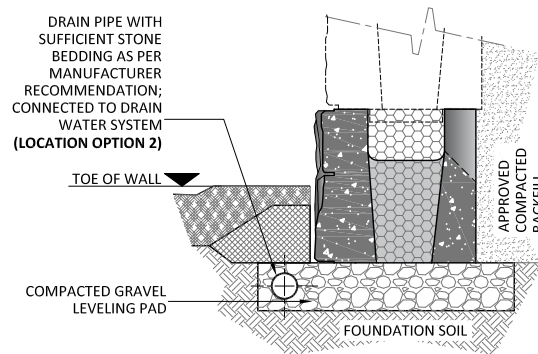
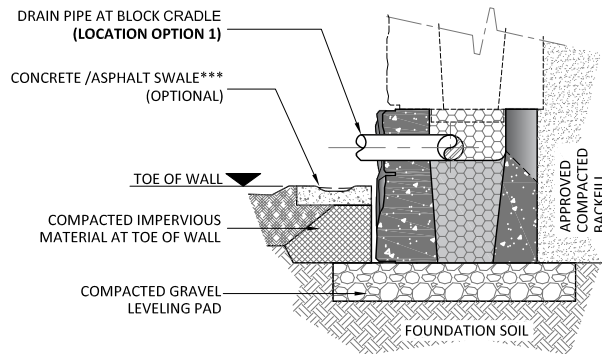

GENERAL NOTE:

- FOR MORE DRAIN PIPE LOCATION OPTIONS OF GRAVITY RETAINING WALLS, PLEASE REFER DRAWING 03 / 103_1102 MS_GVT
- DRAIN PIPE LOCATIONS MENTIONED ABOVE ARE POTENTIAL DESIGN SUGGESTIONS. OTHER OPTIONS ARE AVAILABLE AS PER ENGINEER'S DISCRETION
- WEEPING TILE DAYLIGHTS BY CORING THROUGH BLOCK FACE; OUTLET TO BE SPACED 30-40' [9-12 m]

02 TOE OF WALL DETAILS
SCALE 1:25

SATURATED FOUNDATION SOIL

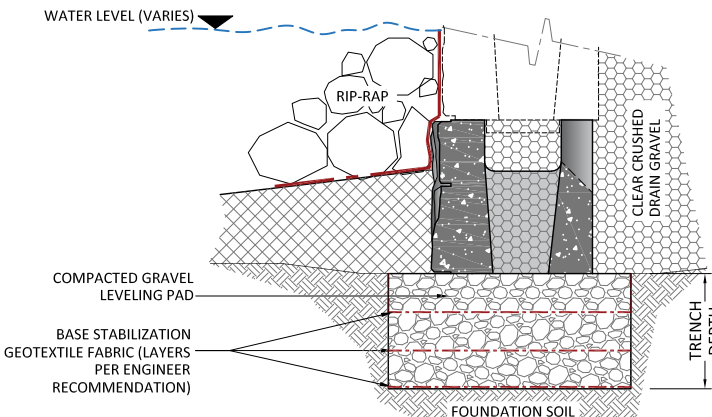

WATER APPLICATION

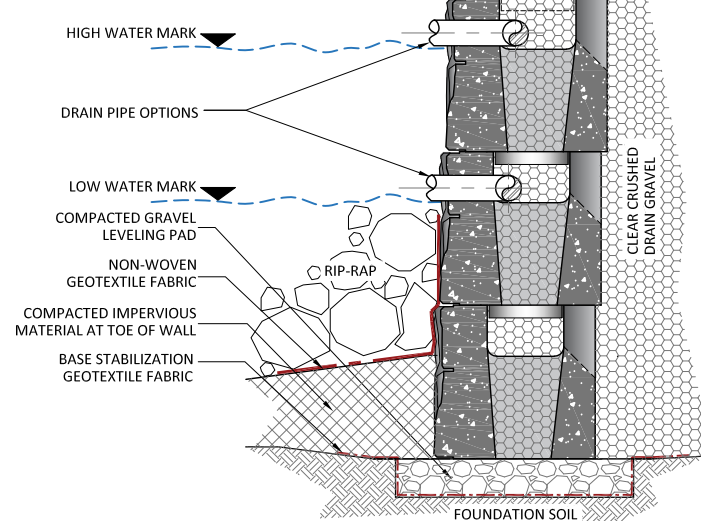

03 GUARDRAIL DETAILS
SCALE 1:50

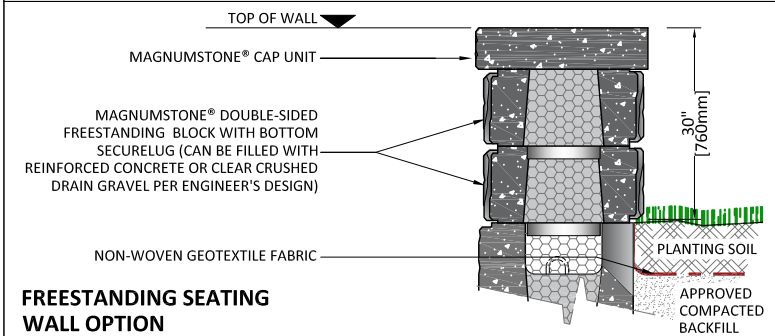

FREESTANDING SEATING WALL OPTION

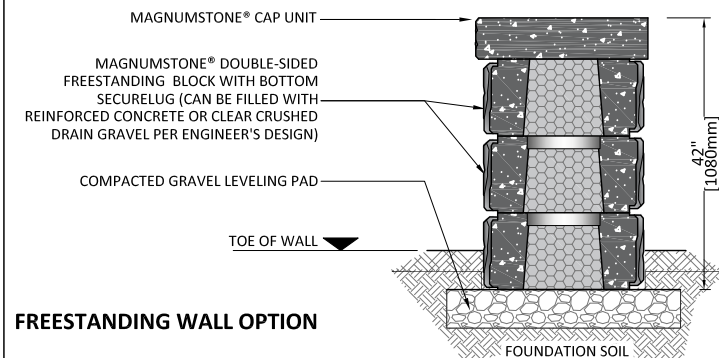

FREESTANDING WALL OPTION

04 FREESTANDING WALL DETAILS
SCALE 1:25

GENERAL NOTES:

These drawings are intended solely to act as an aid when designing a wall. This drawing should not be used for final design or construction.

Each site-specific wall should be certified and signed by a registered geotechnical engineer in the State or Province that it is being built.

The accuracy and use of the details in this document are the sole responsibility of the user.

(*) PLANTABLE GENERAL NOTE:
REFER FULL DETAILS ON PLANTABLE WALL AT DRAWING NO. 1104-MS_PLT

() FENCE GENERAL NOTE:**

1. FENCE POST / RAILING DESIGN BY OTHERS
2. DESIGN TO BE PERFORMED BY ENGINEER

(*) SWALE:**
DEPTH AND WIDTH OF SWALE TO BE DETERMINED BY ENGINEER

(**) POSITIVE CONNECTION DETAILS:** REFER DWG 03/101_1103-MS-PCT

01 ADDENDUM INFORMATION 08-10-2023

00 INTERNAL APPROVAL 07-01-2023

Rev	DESCRIPTION	DATE

REMARKS:

- PURPOSE OF ISSUE:**
- INFORMATION
 - REVIEW / APPROVAL
 - PRODUCTION

SHEET CONTENT

MAGNUMSTONE® GENERAL INFORMATION

COMMON APPLICATIONS TOP OF WALL DETAILS TOE OF WALL DETAILS

SHEET REFERENCE

103

1100-MS-GEN

DRAWING INFORMATION

SCALE: AS INDICATED
PAPER SIZE: 17" WD X 11" HT
PREPARED BY: RM



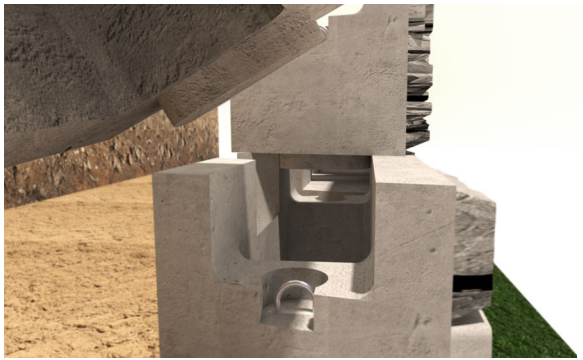
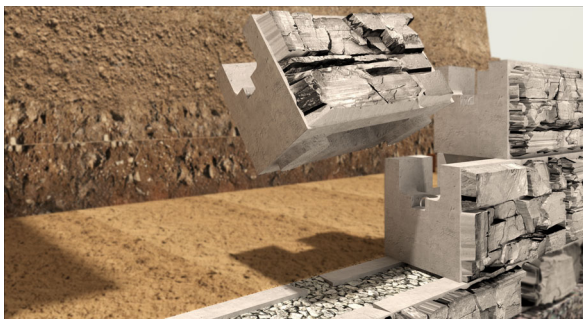

BLOCK INSTALLATION WITH SECURELUG

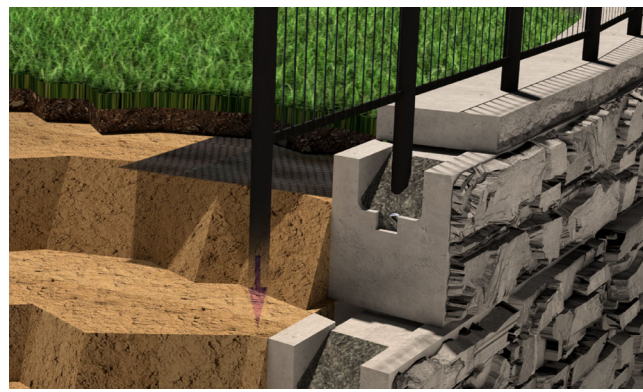

TOP OF WALL OPTIONS

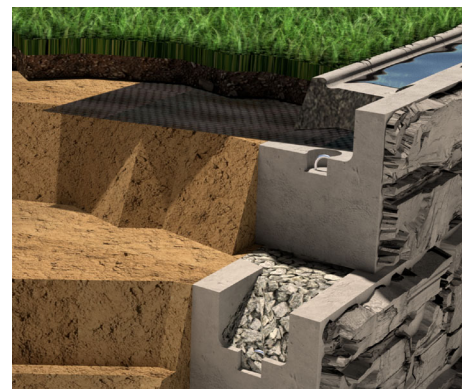

CUT EDGE ACCORDING TO WALL RADIUS / SITE REQUIREMENT

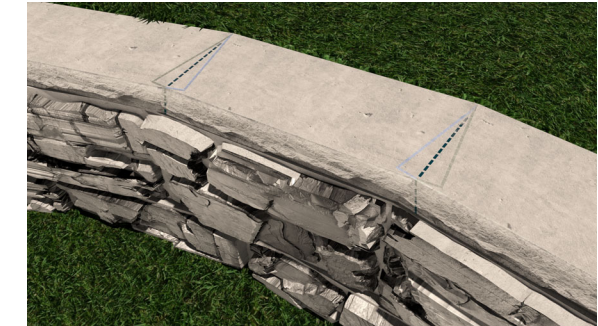

STEP / CAP CURVE INSTALLATION

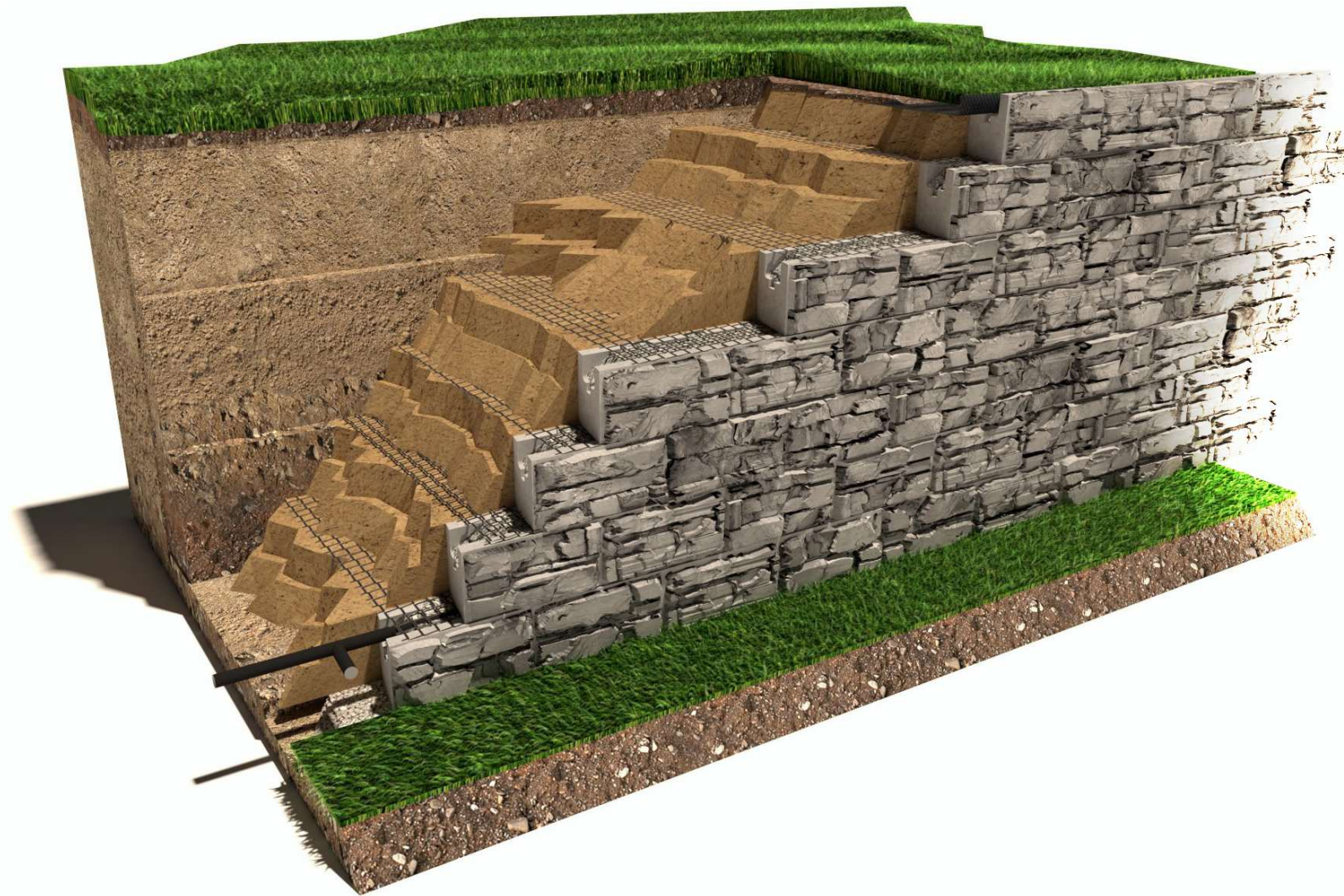

FOUNDATION LAYER

RETAINING WALL PERSPECTIVE (GEOGRID WALL)

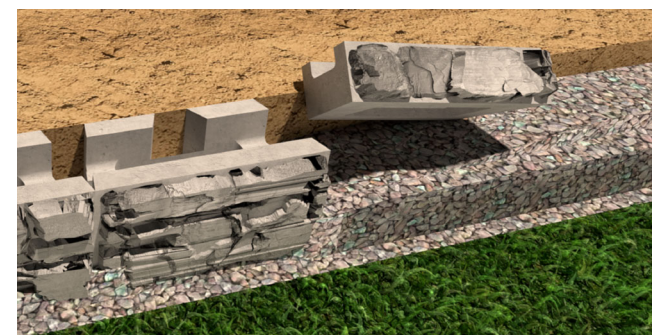

BASE ELEVATION CHANGE



MECHANICAL FIX

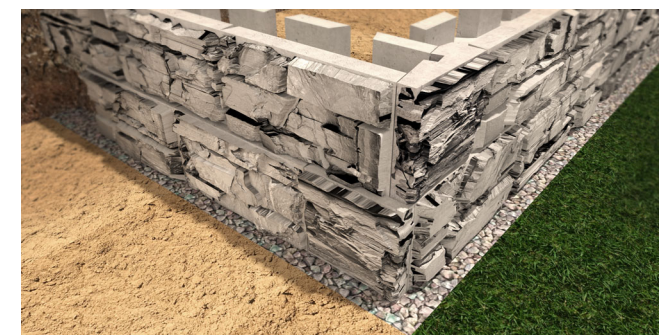

CORNER BLOCK INSTALLATION

GENERAL NOTES:

These drawings are intended solely to act as an aid when designing a wall. This drawing should not be used for final design or construction.

Each site-specific wall should be certified and signed by a registered geotechnical engineer in the State or Province that it is being built.

The accuracy and use of the details in this document are the sole responsibility of the user.

01 ADDENDUM INFORMATION 08-10-2023

00 INTERNAL APPROVAL 07-01-2023

Rev DESCRIPTION DATE

REMARKS:

PURPOSE OF ISSUE:

- INFORMATION
- REVIEW / APPROVAL
- PRODUCTION

SHEET CONTENT

MAGNUMSTONE® PERSPECTIVE

SHEET REFERENCE

201

1100-MS-GEN

DRAWING INFORMATION

SCALE: AS INDICATED
 PAPER SIZE: 17" WD X 11" HT
 PREPARED BY: RM



MagnumStone®
 RETAINING WALLS

www.MAGNUMSTONE.com | 1 (800) 939-9193